

MOUNTING CONFIGURATIONS

Look up your connector part number in our Assembly and Mounting Guide on pages 149-164 and find your assembly diagram here.

FIG. 1

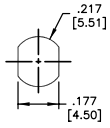

FIG. 2

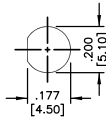

FIG. 3

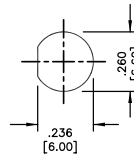

FIG. 4

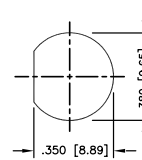

FIG. 5

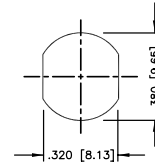

FIG. 6

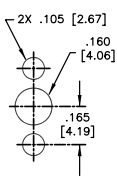

FIG. 7

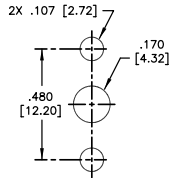

FIG. 8

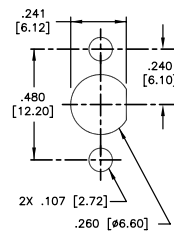

FIG. 9

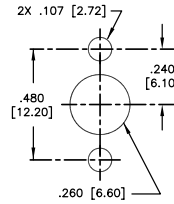

FIG. 10

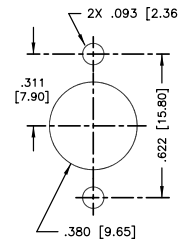

FIG. 11

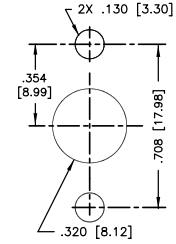

FIG. 12

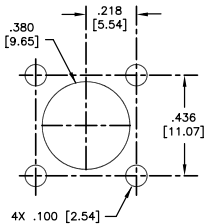

FIG. 13

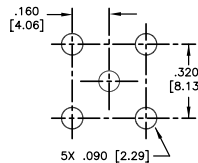

FIG. 14

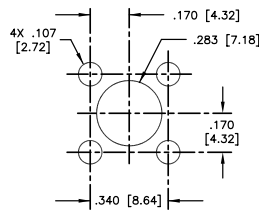

FIG. 15

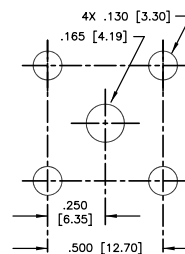

FIG. 16

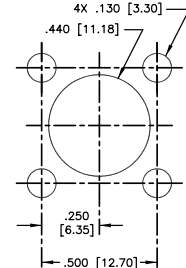

FIG. 17

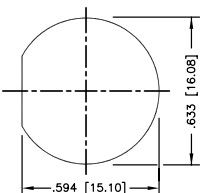

FIG. 18

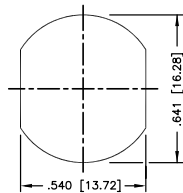

FIG. 19

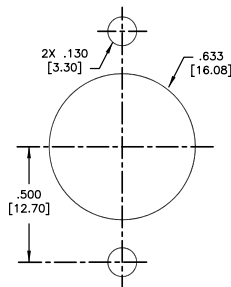

FIG. 20

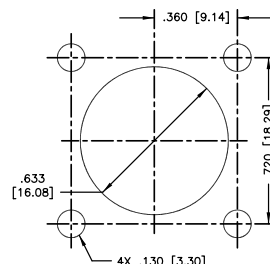
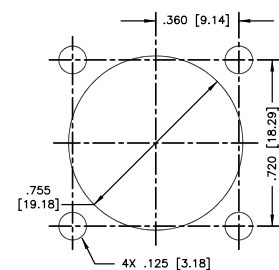

FIG. 21



Use this as a quick reference. Design changes may slightly alter stripping instructions. Contact us for drawings and complete assembly instructions.

FIG. 22

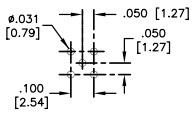

FIG. 23

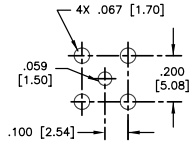

FIG. 24

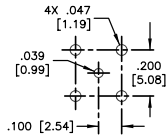

FIG. 25

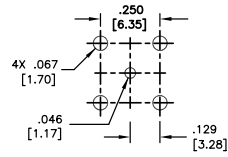

FIG. 26

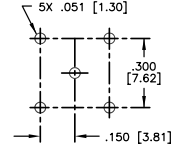

FIG. 27

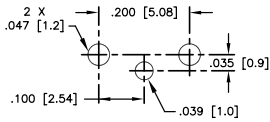

FIG. 28

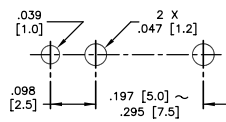

FIG. 29

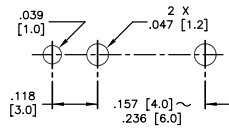

FIG. 30

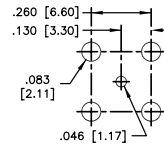

FIG. 31

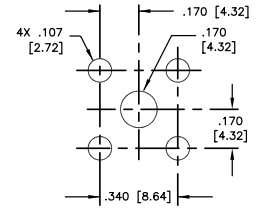

FIG. 32

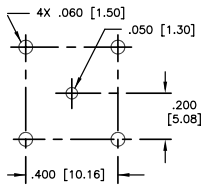

FIG. 33

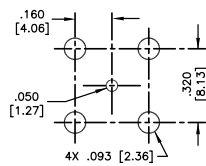

FIG. 34

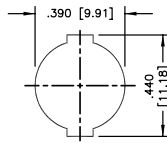

FIG. 35

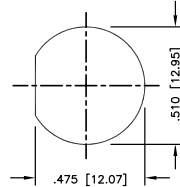

FIG. 36

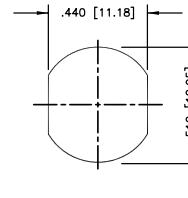

FIG. 37

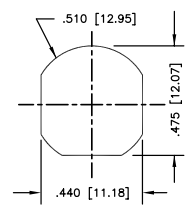

FIG. 38

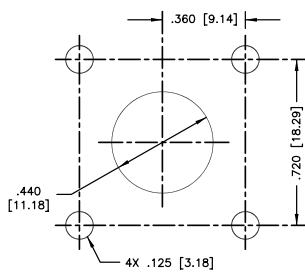

FIG. 39

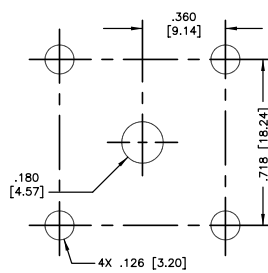

FIG. 40

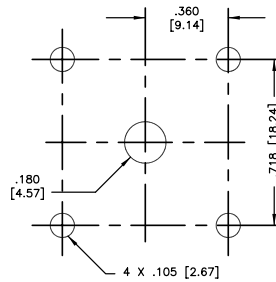
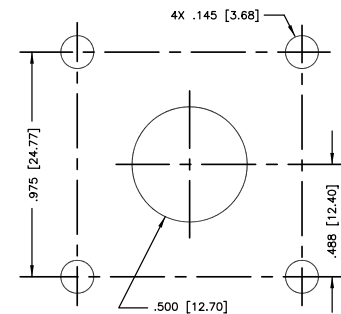

FIG. 41



Use this as a quick reference. Design changes may slightly alter stripping instructions. Contact us for drawings and complete assembly instructions.

FIG. 42

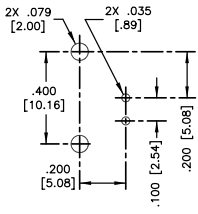

FIG. 43

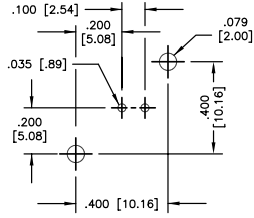

FIG. 44

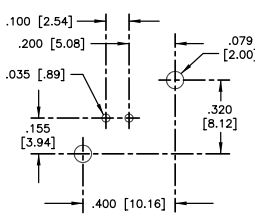

FIG. 45

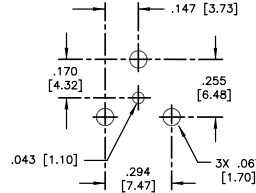

FIG. 46

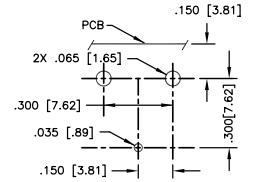

FIG. 47

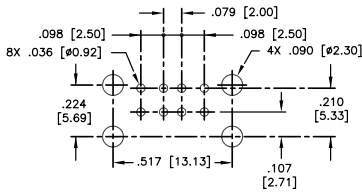

FIG. 48

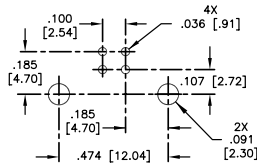

FIG. 49

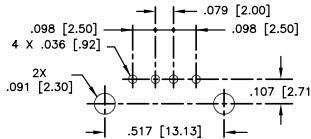

FIG. 50

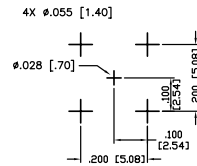

FIG. 51

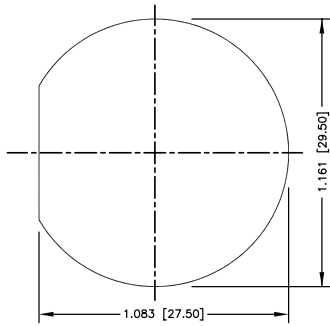

FIG. 52

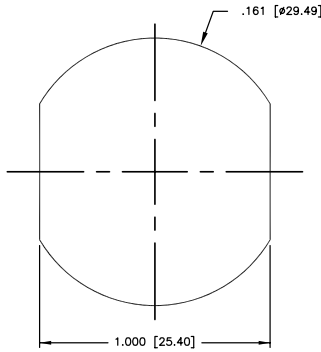

FIG. 53

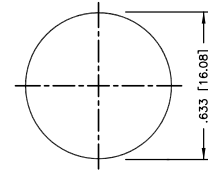

FIG. 54

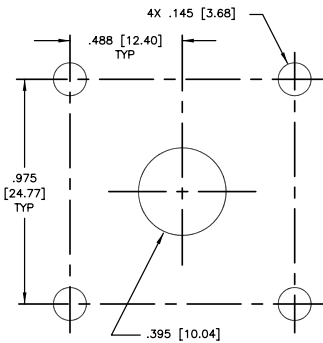

FIG. 55

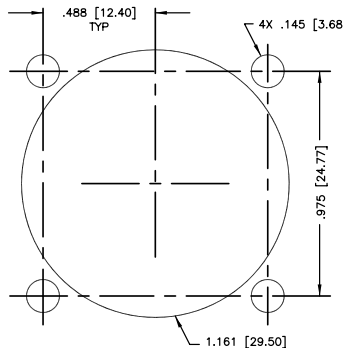
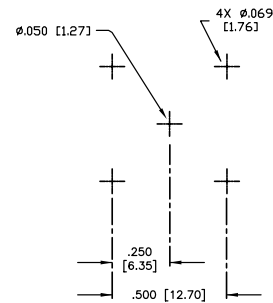

FIG. 56



8490A.DWG

ASSEMBLY & MOUNTING GUIDE

See mounting diagrams in Mounting Configuration section, pages 146-148

Dies for Professional Grade Crimper (RFA-4009-20)



RFA-4009-01

RFA-4009-03

RFA-4009-04

RFA-4009-05

RFA-4009-06

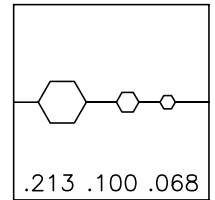
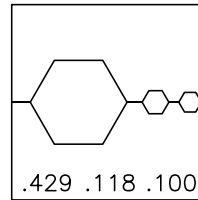
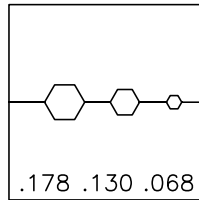
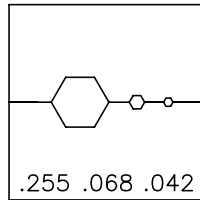
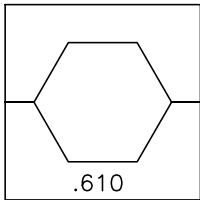

Dies for Commercial Grade Crimper (RFA-4005-20)

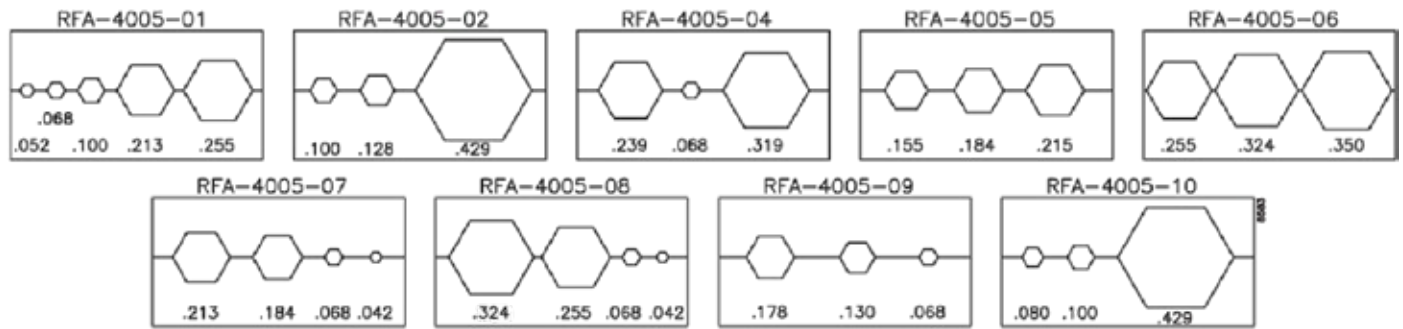

part #	strip A	STRIP B	STRIP C	HEX 1	HEX 2	HEX 3	recommended crimp tool	notes	configuration
PT-4010-030	.16 [4.06]	.07 [1.78]	.325 [8.26]	0.068	0.213		RFA-4009-206		
PT-4010-062									5
RCA-1902	.79 [20.07]	.110 [2.79]	.20 [5.0] Parallel Slit	Solder	0.255		RFA-4009-203		
RCA-1903	.100 [2.54]	.200 [5.08]	.400 [10.16]	Solder	PLIERS				
RCA-1904-01-D	.197 [5.0]	.236 [5.99]	.236 [5.99]				RFA-4004-20	2-Step Strip, Dielectric & Braid Same Cut	
RCA-1904-02-D	.197 [5.0]	.236 [5.99]	.236 [5.99]				RFA-4004-20	2-Step Strip, Dielectric & Braid Same Cut	
RCA-1904-03-D	.197 [5.0]	.236 [5.99]	.236 [5.99]				RFA-4004-20	2-Step Strip, Dielectric & Braid Same Cut	
RDM-6310-B	.050 [1.27]	.07 [1.79]	.225 [5.70]	Solder	0.13		RFA-4009-204		
RF123-7000-B	.079 [2.00]	.079 [2.00]	.205 [5.2]	Solder	0.13		RFA-4009-204		
RF123-7000-B1	.079 [2.00]	.079 [2.00]	.205 [5.2]	Solder	0.13		RFA-4009-204		
RF123-7000-B-03	.079 [2.00]	.079 [2.00]	.205 [5.2]	Solder	0.13		RFA-4009-204		
RF123-7001-B	.098 [2.50]	.063 [1.60]	.205 [5.20]	Solder	0.13		RFA-4009-204		
RF123-7002-B	.098 [2.50]	.067 [1.70]	.205 [5.20]	Solder	0.13		RFA-4005-209		
RF123-7050-1B	.079 [2.00]	.075 [1.91]	.204 [5.19]	Solder	0.13		RFA-4009-204		
RF123-7050-1B1	.079 [2.00]	.075 [1.91]	.204 [5.19]	Solder	0.13		RFA-4009-204		
RF123-7052-1B	.079 [2.00]	.075 [1.91]	.205 [5.20]	Solder	0.13		RFA-4009-204		1
RF123-7300-1									24
RF123-7350-1									24
RF29M-SR1	.085 [2.16]								

ASSEMBLY & MOUNTING GUIDE — continued

See mounting diagrams in Mounting Configuration section, pages 146-148

Use this as a quick reference. Design changes may slightly alter stripping instructions.
Contact us for drawings and complete assembly instructions.

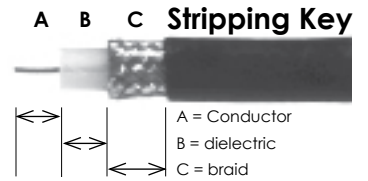

part #	strip A	STRIP B	STRIP C	HEX 1	HEX 2	HEX 3	recommended crimp tool	notes	config-uration
RFB-1100-2	.118 [3.00]	.039 [1.00]	.157 [4.00]	0.068			RFA-4009-204		
RFB-1100-2ST	.118 [3.00]	.039 [1.00]	.157 [4.00]	0.068			RFA-4009-204		
RFB-1100-B	.157 [4.00]	.236 [6.00]	.236 [6.00]	0.068			RFA-4009-204	2-Step Strip, Dielectric & Braid Same Cut	
RFB-1100-C2ST	.118 [3.00]	.04 [1.02]	.157 [4.00]	0.068			RFA-4009-204		
RFB-1101-1EN	.150 [3.81]	.090 [2.29]	.240 [6.10]	0.1			RFA-4009-206	Peel back Braid to cut Dielectric	
RFB-1101-1P	.135 [3.43]	.180 [4.50]	.180 [4.50]	Solder				2-Step Strip, Dielectric & Braid Same Cut	
RFB-1101-1SI	.157 [4.00]	.094 [2.40]	.252 [6.40]	0.128			RFA-4005-200	Peel back Braid to cut Dielectric	
RFB-1101-1X	.135 [3.43]	.180 [4.50]	.180 [4.50]	Solder				2-Step Strip, Dielectric & Braid Same Cut	
RFB-1101-PL	.150 [3.81]	.140 [3.56]	.290 [7.37]	0.128			RFA-4005-200	Peel back Braid to cut Dielectric	
RFB-1102-T	.277 [7.04]	.063 [1.60]	.215 [5.46]	Solder				Jacket sliced two places rather than stripped.	
RFB-1104	.563 [14.30]	.252 [6.40]	.252 [6.40]						
RFB-1106-2	.157 [4.00]	.146 [3.70]	.327 [8.30]	0.068	0.213		RFA-4009-206		
RFB-1106-2ST	.157 [4.00]	.146 [3.70]	.327 [8.30]	0.068	0.213		RFA-4009-206		
RFB-1106-2T	.157 [4.00]	.146 [3.70]	.327 [8.30]	0.068	0.213		RFA-4009-206		
RFB-1106-2TC1	.157 [4.00]	.146 [3.70]	.327 [8.30]	0.068	0.213		RFA-4009-206		
RFB-1106-5	.118 [3.00]	.205 [5.20]	.331 [8.40]	0.13	0.178		RFA-4009-204		
RFB-1106-5B1	.118 [3.00]	.205 [5.20]	.331 [8.40]	0.13	0.178		RFA-4009-204		
RFB-1106-6	.100 [2.54]	.120 [3.05]	.205 [5.20]	0.13	0.178		RFA-4009-204		
RFB-1106-9	.125 [3.18]	.090 [2.29]	.310 [7.87]	0.068	0.213		RFA-4009-206		
RFB-1106-B-ST	.118 [3.00]	.205 [5.20]	.331 [8.40]	0.13	0.178		RFA-4009-204		
RFB-1106-B1	.100 [2.54]	.120 [3.05]	.205 [5.20]	0.13	0.178		RFA-4009-204		
RFB-1106-C-03	.157 [4.00]	.146 [3.70]	.327 [8.30]	0.068	0.213		RFA-4009-206		
RFB-1106-C1	.157 [4.00]	.146 [3.70]	.327 [8.30]	0.068	0.213		RFA-4009-206		
RFB-1106-C1ST	.157 [4.00]	.146 [3.70]	.327 [8.30]	0.068	0.213		RFA-4009-206		
RFB-1106-C2	.160 [4.06]	.145 [3.68]	.325 [8.25]	0.068	0.213		RFA-4009-206		
RFB-1106-C2ST	.157 [4.00]	.150 [3.81]	.327 [8.30]	0.068	0.213		RFA-4009-206		
RFB-1106-C2T	.157 [4.00]	.150 [3.81]	.327 [8.30]	0.068	0.213		RFA-4009-206		
RFB-1106-I	.150 [3.81]	.343 [8.70]	.343 [8.70]	0.128	0.429		RFA-4005-300	2-Step Strip, Dielectric & Braid Same Cut	
RFB-1107-1P	.160 [4.06]	.150 [3.81]	.310 [7.87]	0.068	0.255		RFA-4009-203		
RFB-1107-1X	.160 [4.06]	.145 [3.68]	.325 [8.25]	0.068	0.255		RFA-4009-203		
RFB-1107-7	.157 [4.00]	.146 [3.70]	.327 [8.30]	0.068	0.213		RFA-4009-206		
RFB-1110-1	.157 [4.00]	.193 [4.90]	.327 [8.30]	0.068	0.213		RFA-4009-206		
RFB-1110-B	.161 [4.10]	.220 [5.60]	.268[6.80]	Solder	0.178		RFA-4009-204		
RFB-1110-C-04	.256 [6.50]	.197 [5.00]	.059 [1.50]	Solder				Jacket sliced two places after being stripped.	
RFB-1110-C1	.155 [3.94]	.195 [4.95]	.325 [8.25]	0.068	0.213		RFA-4009-206		
RFB-1110-C1ST	.157 [4.00]	.155 [3.94]	.327 [8.30]	0.068	0.213		RFA-4009-206		
RFB-1110-C2	.157 [4.00]	.193 [4.90]	.327 [8.30]	0.068	0.213		RFA-4009-206		
RFB-1111								.505" Dia. Mtg. Hole w/ D-Flat; 2 Holes .4 O/C	35, 42
RFB-1112-1B								.505" Dia. Mtg. Hole w/ D-Flat; 2 Holes .4 O/C	35, 44
RFB-1112-1B-03								.505" Dia. Mtg. Hole w/ D-Flat; 2 Holes .4 O/C	35, 44
RFB-1112-1W								.505" Dia. Mtg. Hole w/ D-Flat; 2 Holes .4 O/C	35, 43
RFB-1112-B								.505" Dia. Mtg. Hole w/ D-Flat; 2 Holes .4 O/C	35, 42
RFB-1112-B-03								.505" Dia. Mtg. Hole w/ D-Flat; 2 Holes .4 O/C	35, 42
RFB-1112-W								.510" Dia. Mtg. Hole w/ D-Flat; 2 Holes .4 O/C	35, 42
RFB-1112-W-03								.505" Dia. Mtg. Hole w/ D-Flat; 2 Holes .4 O/C	35, 42
RFB-1113-1B								.505" Dia. Mtg. Hole w/ D-Flat; 2 Holes .4 O/C	35, 43
RFB-1113-1B-03								.505" Dia. Mtg. Hole w/ D-Flat; 2 Holes .4 O/C	35, 43
RFB-1113-1W								.505" Dia. Mtg. Hole w/ D-Flat; 2 Holes .4 O/C	35, 43



ASSEMBLY & MOUNTING GUIDE — continued

See mounting diagrams in Mounting Configuration section, pages 146-148

Use this as a quick reference. Design changes may slightly alter stripping instructions.
Contact us for drawings and complete assembly instructions.

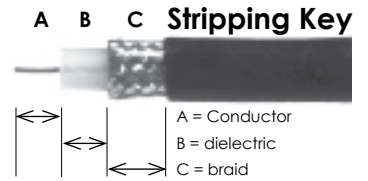

part #	strip A	STRIP B	STRIP C	HEX 1	HEX 2	HEX 3	recommended crimp tool	notes	config-uration
RFB-1113-1W-03								.505" Dia. Mtg. Hole w/ D-Flat; 2 Holes .4 O/C	35, 43
RFB-1113-B								.505" Dia. Mtg. Hole w/ D-Flat; 2 Holes .4 O/C	35, 42
RFB-1113-B-04								.510" Dia. Mtg. Hole w/ D-Flat; 2 Holes .4 O/C	35, 42
RFB-1113-W								.510" Dia. Mtg. Hole w/ D-Flat; 2 Holes .4 O/C	35, 42
RFB-1113-W-03								.505" Dia. Mtg. Hole w/ D-Flat; 2 Holes .4 O/C	35, 42
RFB-1115								4 Holes, .500" O/C	16
RFB-1115-14								4 Holes, .720" O/C	38
RFB-1115-21								4 Holes, .500" O/C	56
RFB-1115-3									45
RFB-1115-4								4 Holes, .250" O/C	25
RFB-1115-6								4 Holes, .260" O/C	30
RFB-1115-S								4 Holes, .500" O/C	16
RFB-1116								.380" Dia. Mtg. Hole w/ D-Flat	4
RFB-1116-11								.382" Dia. Mtg. Hole w/ D-Flat	4
RFB-1116-3								.380" Dia. Mtg. Hole w/ D-Flat	4
RFB-1116-B-03	.110 [2.79]	.130 [3.30]	.275 [6.99]	0.068	0.184		RFA-4005-100 & RFA-4005-05	.382" Dia. Mtg. Hole w/ D-Flat	4
RFB-1116-I								.380" Dia. Mtg. Hole w/ D-Flat	4
RFB-1116-I-03								.380" Dia. Mtg. Hole w/ D-Flat	35
RFB-1116-NG								.380" Dia. Mtg. Hole w/ D-Flat	4
RFB-1116-NG-03								.380" Dia. Mtg. Hole w/ D-Flat	4
RFB-1116-SG								.380" Dia. Mtg. Hole w/ D-Flat	4
RFB-1117	.140 [3.56]	.195 [4.95]	.325 [8.26]	0.068	0.213		RFA-4009-206	.510" Dia. Mtg. Hole w/ D-Flat	35
RFB-1117-B1-T	.150 [3.81]	.195 [4.95]	.315[8.00]	0.068	0.178		RFA-4009-204	Jacket sliced .08" two places after being stripped.	35
RFB-1117-BT	.150 [3.81]	.195 [4.95]	.315[8.00]	0.068	0.178		RFA-4009-204	Jacket sliced .08" two places after being stripped.	35
RFB-1117-BT-03	.157 [4.00]	.323 [8.20]	.268 [6.81]	0.068	0.178		RFA-4009-204	.512" Dia. Mtg. Hole w/ D-Flat	35
RFB-1117-BT-04									35
RFB-1117-C1	.140 [3.56]	.195 [4.95]	.325 [8.26]	0.068	0.213		RFA-4009-206	.510" Dia. Mtg. Hole w/ D-Flat	35
RFB-1117-C1T	.140 [3.56]	.195 [4.95]	.325 [8.26]	0.068	0.213		RFA-4009-206	.510" Dia. Mtg. Hole w/ D-Flat	35
RFB-1117-C2	.140 [3.56]	.195 [4.95]	.325 [8.26]	0.068	0.213		RFA-4009-206	.510" Dia. Mtg. Hole w/ D-Flat	35
RFB-1121	.563 [14.30]	.252 [6.40]	.252 [6.40]					2-Step Strip, Dielectric & Braid Same Cut	
RFB-1123-1	.140 [3.56]	.063 [1.6]	.331 [8.40]	0.068	0.213		RFA-4009-206		
RFB-1123-1-SS	.140 [3.56]	.063 [1.6]	.331 [8.40]	0.068	0.213		RFA-4009-206		
RFB-1123-C1	.140 [3.56]	.063 [1.6]	.331 [8.40]	0.068	0.213		RFA-4009-206		
RFB-1123-C2	.140 [3.56]	.070 [1.78]	.325 [8.26]	0.068	0.213		RFA-4009-206		
RFB-1124-1P	.150 [3.81]	.166 [4.22]	.329 [8.35]	0.068	0.255		RFA-4009-203		
RFB-1124-1X	.160 [4.06]	.145 [3.68]	.325 [8.26]	0.068	0.255		RFA-4009-203		
RFB-1154								.382" Dia. Mtg. Hole w/ D-Flat	4
RFB-1160	.173 [4.40]	.173 [4.39]	.323 [8.20]	0.068	0.213		RFA-4009-206		
RFB-1701-D	.138 [3.50]	.177 [4.50]	.177 [4.50]	Solder				2-Step Strip, Dielectric & Braid Same Cut	
RFB-1704-D	.197 [5.00]	.236 [5.99]	.236 [5.99]				RFA-4004-01	2-Step Strip, Dielectric & Braid Same Cut	
RFB-1704-Q	.197 [5.00]	.236 [5.99]	.236 [5.99]				RFA-4004-01	2-Step Strip, Dielectric & Braid Same Cut	
RFB-1705	.563 [14.30]	.252 [6.40]	.252 [6.40]					2-Step Strip, Dielectric & Braid Same Cut	
RFB-1706-9	.150 [3.81]	.125 [3.18]	.325 [8.26]	0.068	0.255		RFA-4009-203		
RFB-1707-2	.157 [4.00]	.146 [3.70]	.327 [8.30]	0.068	0.255		RFA-4009-203		
RFB-1707-D	.157 [4.00]	.146 [3.70]	.327 [8.30]	0.068	0.255		RFA-4009-203		
RFB-1707-D2	.157 [4.00]	.146 [3.70]	.327 [8.30]	0.068	0.255		RFA-4009-203		
RFB-1707-D3	.157 [4.00]	.146 [3.70]	.327 [8.30]	0.068	0.255		RFA-4009-203		
RFB-1707-G	.157 [4.00]	.146 [3.70]	.327 [8.30]	0.068	0.324		RFA-4005-308		



ASSEMBLY & MOUNTING GUIDE — continued

See mounting diagrams in Mounting Configuration section, pages 146-148

Use this as a quick reference. Design changes may slightly alter stripping instructions.
Contact us for drawings and complete assembly instructions.

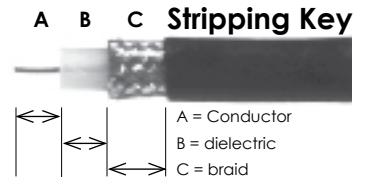

part #	strip A	STRIP B	STRIP C	HEX 1	HEX 2	HEX 3	recommended crimp tool	notes	config-uration
RFB-1707-J	.157 [4.00]	.146 [3.70]	.327 [8.30]	0.042	0.184		RFA-4005-307		
RFB-1707-K	.157 [4.00]	.146 [3.70]	.327 [8.30]	0.042	0.184		RFA-4005-307		
RFB-1707-Q	.157 [4.00]	.146 [3.70]	.327 [8.30]	0.068	0.324		RFA-4005-308		
RFB-1707-Q1	.157 [4.00]	.146 [3.70]	.327 [8.30]	0.068	0.324		RFA-4005-308		
RFB-1707-R	.157 [4.00]	.146 [3.70]	.327 [8.30]	Solder	0.429		RFA-4009-205		
RFB-1707-R1	.157 [4.00]	.146 [3.70]	.327 [8.30]	Solder	0.429		RFA-4009-205		
RFB-1707-S	.157 [4.00]	.150 [3.81]	.256 [6.49]	0.042	0.178		RFA-4005-307		
RFB-1708	.157 [4.00]	.136 [3.45]	.331 [8.4]	0.068	0.324		RFA-4005-308		
RFB-1708-1T	.138 [3.50]	.197 [5.00]	.295 [7.49]	Solder	0.315		RFA-4005-308		
RFB-1709-D	.256 [6.50]	.197 [5.00]	.059 [1.50]	Solder				Slit jacket .157" two places after stripping.	
RFB-1710-D	.157 [4.00]	.193 [4.90]	.327 [8.30]	0.068	0.255		RFA-4009-203		
RFB-1710-K	.142 [3.60]	.315 [8.00]	.327 [8.30]	Solder	0.184		RFA-4005-305		
RFB-1710-Q	.161 [4.10]	.220 [5.60]	.327 [8.30]	Solder	0.324		RFA-4005-308		
RFB-1710-S	.161 [4.10]	.220 [5.60]	.268 [6.80]	Solder	0.178		RFA-4005-307		
RFB-1710-S1	.161 [4.10]	.220 [5.60]	.268 [6.80]	Solder	0.178		RFA-4005-307		
RFB-1712-W								.500" Dia. Mtg. Hole w/ D-Flat	35, 42
RFB-1715-6								4 Mtg. Holes .260" O/C	30
RFB-1715-11								4 Mtg. Holes .400" O/C	32
RFB-1716								.380" Dia. Mtg. Hole w/ D-Flat	4
RFB-1716-1								.380" Dia. Mtg. Hole w/ D-Flat	4
RFB-1717	.197 [5.00]	.165 [4.20]	.327 [8.30]	0.068	0.255		RFA-4009-203	.512" Dia. Mtg. Hole w/ D-Flat	35
RFB-1717-Q	.157 [4.00]	.205 [5.20]	.327 [8.30]	0.068	0.255		RFA-4009-203		35
RFB-1717-S	.157 [4.00]	.205 [5.20]	.331 [8.40]	0.068	0.178		RFA-4009-204	.512" Dia. Mtg. Hole w/ D-Flat	35
RFB-1720	.138 [3.50]	.157 [4.00]	.157 [4.00]	Solder				2-Step Strip, Dielectric & Braid Same Cut	
RFB-1722	.563 [14.30]	.252 [6.40]	.252 [6.40]					2-Step Strip, Dielectric & Braid Same Cut	
RFB-1724	.157 [4.00]	.146 [3.70]	.327 [8.30]	0.068	0.255		RFA-4009-203		
RFB-1724-K	.157 [4.00]	.146 [3.70]	.327 [8.30]	0.042	0.178		RFA-4005-307		
RFB-1724-Q	.157 [4.00]	.146 [3.70]	.327 [8.30]	0.0698	0.324		RFA-4005-308		
RFB-1724-S	.157 [4.00]	.146 [3.70]	.331 [8.40]	0.068	0.178		RFA-4009-204		
RFB-1724-S1	.157 [4.00]	.146 [3.70]	.331 [8.40]	0.068	0.178		RFA-4009-204		
RFB-1760	.150 [3.81]	.015 [3.81]	.325 [8.25]	0.068	0.255		RFA-4009-203		
RFD-1604-2I	.197 [5.00]	.197 [5.00]	.327 [8.30]		0.429		RFA-4009-205		
RFD-1604-2L2	.197 [5.00]	.205 [5.20]	.390 [9.90]		0.61		RFA-4009-201		
RFD-1605-2-C	.325 [8.26]	.57 [14.48]	.325 [8.25]	Solder	0.213		RFA-4009-206	Straight	
	.175 [4.45]	.54 [13.72]	.325 [8.26]	Solder	0.213		RFA-4009-206	Right-Angle	
RFD-1605-2-C1	.240 [6.10]	.413 [10.50]	.327 [8.30]	Solder	0.213		RFA-4009-206		
RFD-1605-2-E	.325 [8.26]	.57 [14.48]	.325 [8.25]	Solder	0.429		RFA-4009-205	Straight	
	.175 [4.45]	.54 [13.72]	.325 [8.26]	Solder	0.429		RFA-4009-205	Right-Angle	
RFD-1605-2-L2	.374 [9.50]	.413 [10.5]	.406 [10.30]	SOLDER	0.6			2-Step Strip, Dielectric & Braid Same Cut	
RFD-1605-2-X	.175 [4.45]	.54 [13.72]	.325 [8.26]	Solder	0.255		RFA-4009-203	Right-Angle	
	.325 [8.26]	.57 [14.48]	.325 [8.25]	Solder	0.255		RFA-4009-203	Straight	
RFD-1625-2-E	.32 [8.13]	.445 [11.30]	.285 [7.24]	Solder			RFA-4009-205	Straight	
	.175 [4.45]	.41 [10.41]	.285 [7.24]	Solder			RFA-4009-205	Right-Angle	
RFD-1630-2-C	.325 [8.26]	.57 [14.48]	.325 [8.25]	Solder	0.213		RFA-4009-206	Straight	
	.175 [4.45]	.54 [13.72]	.325 [8.26]	Solder	0.213		RFA-4009-206	Right-Angle	
RFD-1630-2-C1	.325 [8.26]	.57 [14.48]	.325 [8.25]	Solder	0.213		RFA-4009-206	Straight	
	.175 [4.45]	.54 [13.72]	.325 [8.26]	Solder	0.213		RFA-4009-206	Right-Angle	
RFD-1630-2-E	.325 [8.26]	.57 [14.48]	.325 [8.25]	Solder	0.429		RFA-4009-205	Straight	



ASSEMBLY & MOUNTING GUIDE — continued

See mounting diagrams in Mounting Configuration section, pages 146-148

Use this as a quick reference. Design changes may slightly alter stripping instructions.
Contact us for drawings and complete assembly instructions.

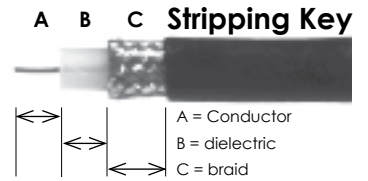

part #	strip A	STRIP B	STRIP C	HEX 1	HEX 2	HEX 3	recommended crimp tool	notes	configuration
	.175 [4.45]	.54 [13.72]	.325 [8.26]	Solder	0.429		RFA-4009-205	Right-Angle	
RFD-1630-2-X	.175 [4.45]	.54 [13.72]	.325 [8.26]	Solder	0.255		RFA-4009-203	Right-Angle	
	.325 [8.26]	.57 [14.48]	.325 [8.25]	Solder	0.255		RFA-4009-203	Straight	
RFD-1631-2L2	.197 [5.00]	.205 [5.20]	.390 [9.90]		0.61		RFA-4009-201		
RFD-1640-2								4 .145" Dia. Holes, .975" O/C	55
RFD-1643-HS									54
RFD-1644-2SR1	.180 [4.57]							4 .145" Dia. Holes, .975" O/C	55
RFD-1644-2SR2	.180 [4.57]							4 .145" Dia. Holes, .975" O/C	55
RFD-1644-2SR3	.180 [4.57]							4 .145" Dia. Holes, .975" O/C	55
RFE-6000-B	.091 [2.30]	.118 [3.00]	.236 [6.00]	0.042	0.13		RFA-4009-204		
RFE-6000-C	.118 [3.00]	.158 [4.01]	.295 [7.50]	Solder	0.213		RFA-4009-206		
RFE-6050-C	.138 [3.50]	.177 [4.50]	.315 [8.00]	0.068	0.213		RFA-4009-206		
RFE-6050-C1	.138 [3.50]	.177 [4.50]	.315 [8.00]	0.068	0.213		RFA-4009-206		
RFE-6050-C2	.138 [3.50]	.177 [4.50]	.315 [8.00]	0.068	0.213		RFA-4009-206		
RFE-6050-X	.157 [4.00]	.252 [6.40]	.327 [8.30]	0.068	0.255		RFA-4009-203		
RFF-1402-08	.390 [9.90]	.252 [6.40]	.252 [6.40]				RFA-4005-306	2-Step Strip, Dielectric & Braid Same Cut	
RFF-1402-D	.230 [5.84]	.280 [7.11]	.280 [7.11]		20		RFA-4005-306	2-Step Strip, Dielectric & Braid Same Cut	
RFF-1442								.380 Dia. Blkhd. Mtg. Hole w/ D-Flat; 4 Holes .320 O/C	4, 33
RFF-1442-03								.380 Dia. Blkhd. Mtg. Hole w/ D-Flat; 4 Holes .320 O/C	4,33
RFF-1442-1								.380 Dia. Blkhd. Mtg. Hole w/ D-Flat; 4 Holes .320 O/C	4, 33
RFF-1444								.380 Dia. Blkhd. Mtg. Hole w/ Dbl. D-Flat	5
RFF-1450-03								4 Holes .320 O/C	13
RFN-1000-1S	.150 [3.80]	.142 [3.60]	.142 [3.60]	0.068			RFA-4009-206	2-Step Strip, Dielectric & Braid Same Cut	
RFN-1000-C2	.155 [3.94]	.120 [3.05]	.120 [3.05]	0.068			RFA-4009-206	2-Step Strip, Dielectric & Braid Same Cut	
RFN-1000-C2S	.155 [3.94]	.120 [3.05]	.120 [3.05]	0.068			RFA-4009-206	2-Step Strip, Dielectric & Braid Same Cut	
RFN-1000-N	.150 [3.80]	.142 [3.60]	.142 [3.60]	0.068			RFA-4009-206	2-Step Strip, Dielectric & Braid Same Cut	
RFN-1001-S	.441 [11.20]	.02 [.51]	.287 [7.30]	Solder					
RFN-1002-1N	.177 [4.50]	.138 [3.50]	.295 [7.50]	0.1			RFA-4009-206	Peel back Braid to cut Dielectric	
RFN-1002-1S	.155 [3.94]	.115 [2.92]	.270 [6.86]	0.1			RFA-4009-206	Peel back Braid to cut Dielectric	
RFN-1002-1SI	.177 [4.50]	.124 [3.16]	.302 [7.66]	0.128			RFA-4005-200	Peel back Braid to cut Dielectric	
RFN-1002-2L2	.177 [4.50]	.063 [1.60]	.197 [5.00]	Solder				Peel back Braid to cut Dielectric	
RFN-1002-PL	.177 [4.50]	.138 [3.50]	.295 [7.50]	0.118			RFA-4009-205	Peel back Braid to cut Dielectric	
RFN-1004-1SP	.150 [3.81]	.140 [3.56]	.140 [3.56]	0.068			RFA-4009-206	2-Step Strip, Dielectric & Braid Same Cut	
RFN-1004-1SX	.150 [3.81]	.138 [3.50]	.287 [7.30]	0.068			RFA-4009-206	Peel back Braid to cut Dielectric	
RFN-1005-1SR1	.138 [3.51]							1-Step Strip	
RFN-1005-1SR2	.138 [3.51]							1-Step Strip	
RFN-1005-2N	.157 [4.00]	.110 [2.80]	.327 [8.30]	0.1	0.213		RFA-4009-206		
RFN-1005-3C	.157 [4.00]	.110 [2.80]	.327 [8.30]	0.1	0.213		RFA-4009-206		
RFN-1005-3C1	.157 [4.00]	.110 [2.80]	.327 [8.30]	0.1	0.213		RFA-4009-206		
RFN-1005-5	.16 [4.06]	.125 [3.18]	.325 [8.25]	0.1	0.213		RFA-4009-206		
RFN-1005-7	.157 [4.00]	.146 [3.70]	.327 [8.30]	0.1	0.213		RFA-4009-206		
RFN-1005-B-03	.209 [5.30]	.248 [6.30]	.276 [7.00]	0.1	0.13		RFA-4005-200		
RFN-1005-B1-03	.209 [5.30]	.248 [6.30]	.276 [7.00]	0.1	0.13		RFA-4005-200		
RFN-1005-C1	.150 [3.81]	.085 [2.16]	.325 [8.25]	0.1	0.213		RFA-4009-206		
RFN-1005-C2	.157 [4.00]	.146 [3.70]	.327 [8.30]	0.1	0.213		RFA-4009-206		
RFN-1005-C2S	.150 [3.81]	.09 [2.29]	.323 [8.20]	0.1	0.213		RFA-4009-206		
RFN-1006-2L2	.256 [6.50]	.122 [3.10]	.390 [9.90]	0.184	0.61		RFA-4009-201		
RFN-1006-3E	.135 [3.43]	.08 [2.03]	.325 [8.25]	0.1	0.429		RFA-4009-205		
RFN-1006-3F	.135 [3.43]	.08 [2.03]	.325 [8.25]	0.1	0.429		RFA-4009-205		



ASSEMBLY & MOUNTING GUIDE — continued

See mounting diagrams in Mounting Configuration section, pages 146-148

Use this as a quick reference. Design changes may slightly alter stripping instructions.
Contact us for drawings and complete assembly instructions.

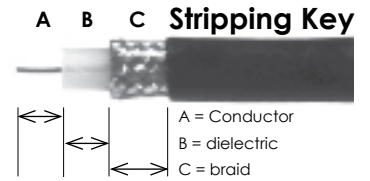

part #	strip A	STRIP B	STRIP C	HEX 1	HEX 2	HEX 3	recommended crimp tool	notes	config-uration
RFN-1006-3I	.177 [4.50]	.085 [2.17]	.374 [9.50]	0.128	0.429		RFA-4005-200		
RFN-1006-8I	.197 [5.00]	.205 [5.20]	.327 [8.30]		0.429		RFA-4009-205		
RFN-1006-8X	.190 [4.82]	.180 [4.57]	.300 [7.61]		0.255		RFA-4009-203		
RFN-1006-9I	.197 [5.00]	.205 [5.20]	.327 [8.30]		0.429		RFA-4009-205		
RFN-1006-9L2	.187 [4.75]	.250 [6.35]	.550 [14.0]		.610		rfa-4009-201		
RFN-1006-9X	.190 [4.82]	.180 [4.57]	.300 [7.61]		0.255		RFA-4009-203		
RFN-1006-I	.130 [3.30]	.085 [2.17]	.325 [8.25]	0.128	0.429		RFA-4005-200		
RFN-1006-I-15	.177 [4.50]	.085 [2.17]	.374 [9.50]	0.128	0.429		RFA-4005-200		
RFN-1006-I-WB	.150 [3.81]	.170 [4.32]	.375 [9.50]	.118	.429		RFA-4005-205		
RFN-1006-L6	.157 [4.00]	.146 [3.70]	.327 [8.30]	0.1	0.324		RFA-4005-308		
RFN-1006-PL	.17 [4.32]	.06 [1.4]	.325 [8.25]	0.128	0.429		RFA-4005-200		
RFN-1007-2SP	.150 [3.80]	.082 [2.08]	.323 [8.20]	0.068	0.255		RFA-4009-203		
RFN-1007-2SX	.150 [3.80]	.082 [2.08]	.323 [8.20]	0.068	0.255		RFA-4009-203		
RFN-1007-X	.150 [3.80]	.082 [2.08]	.323 [8.20]	0.1	0.255		RFA-4005-400		
RFN-1009-3E	.125 [3.18]	.175 [4.45]	.325 [8.25]	Solder	0.429		RFA-4009-205		
RFN-1009-3I	.140 [3.56]	.145 [3.68]	.325 [8.25]	Solder	0.429		RFA-4009-205		
RFN-1009-B-03	.157 [4.00]	.315 [8.00]	.327 [8.30]	Solder	0.178		RFA-4009-204		
RFN-1009-C	.150 [3.80]	.141 [3.58]	.323 [8.20]	0.1	0.213		RFA-4009-206		
RFN-1009-C-03	.06 [1.52]	.355 [9.02]	.325 [8.25]		0.213		RFA-4009-206		
RFN-1009-C1	.140 [3.56]	.145 [3.68]	.325 [8.25]	0.1	0.213		RFA-4009-206		
RFN-1009-C1-03	.06 [1.52]	.355 [9.02]	.325 [8.25]		0.213		RFA-4009-206		
RFN-1009-C2	.140 [3.56]	.145 [3.68]	.325 [8.25]	0.1	0.213		RFA-4009-206		
RFN-1009-I	.232 [5.90]	.263 [6.68]	.327 [8.30]		0.429		RFA-4009-205		
RFN-1009-I-99	.157 [4.00]	.106 [2.70]	.346 [8.80]	0.128	0.429		RFA-4005-300		
RFN-1009-PL	.149 [3.78]	.140 [3.56]	.325 [8.25]	Solder	0.429		RFA-4009-205		
RFN-1009-X-04	.150 [3.80]	.315 [8.00]	.327 [8.30]		0.255		RFA-4009-203		
RFN-1020-1									19
RFN-1021									20
RFN-1021-03									20
RFN-1021-1									20
RFN-1021-11									20
RFN-1021-14									20
RFN-1021-2									20
RFN-1021-2SR2	.138 [3.50]			0.1			RFA-4009-206		20
RFN-1021-4								4 Holes, .500" O/C	15
RFN-1021-5								4 Holes, .500" O/C	15
RFN-1021-6	.150 [3.80]	.138 [3.50]	.138 [3.50]	0.068			RFA-4009-206	4 Holes, .720" O/C, 2-Step Strip, Dielectric & Braid Same Cut	20
RFN-1021-SR3									20
RFN-1022								.630" Dia. Mounting Hole, No D-Flats	53
RFN-1022-1								.641" Dia. Mounting Hole, Dbl D-Flats	18
RFN-1022-2SR2	.161 [4.10]			0.1			RFA-4009-206	.634" Dia. Mounting Hole, Dbl D-Flats	18
RFN-1022-3								.641" Dia. Mounting Hole, Dbl D-Flats	18
RFN-1022-3-03								.641" Dia. Mounting Hole, Dbl D-Flats	18
RFN-1022-5								.380" Dia. Mounting Hole, D-Flat	4
RFN-1022-5-03									4
RFN-1022-8	.098 [2.50]	.122 [3.10]	.205 [5.20]	Solder	0.13		RFA-4009-204		18
RFN-1022-8-B1	.098 [2.50]	.122 [3.10]	.205 [5.20]	Solder	0.13		RFA-4009-204		18
RFN-1022-8-C	.177 [4.50]	.307 [7.80]	.327 [8.30]	0.1	0.213		RFA-4009-206		18



ASSEMBLY & MOUNTING GUIDE — continued

See mounting diagrams in Mounting Configuration section, pages 146-148

Use this as a quick reference. Design changes may slightly alter stripping instructions.
Contact us for drawings and complete assembly instructions.

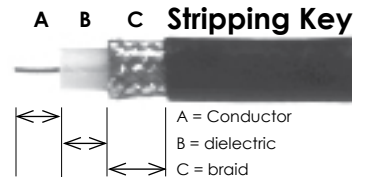

part #	strip A	STRIP B	STRIP C	HEX 1	HEX 2	HEX 3	recommended crimp tool	notes	config-uration
RFN-1022-8-C1	.177 [4.50]	.307 [7.80]	.327 [8.30]	0.1	0.213		RFA-4009-206		18
RFN-1022-8-C2	.177 [4.50]	.307 [7.80]	.327 [8.30]	0.1	0.213		RFA-4009-206		18
RFN-1022-8-M	.177 [4.50]	.307 [7.80]	.327 [8.30]	0.1	0.213		RFA-4009-206		18
RFN-1022-SR1	.138 [3.50]			Solder					18
RFN-1022-SR2	.138 [3.50]			Solder					18
RFN-1022-SR3	.138 [3.50]			Solder					18
RFN-1022-X	.177 [4.50]	.307 [7.80]	.327 [8.30]	0.1	0.255		RFA-4005-400		18
RFN-1024-1	.177 [4.50]	.118 [3.00]	.295 [7.50]	Solder				Peel back Braid to cut Dielectric	
RFN-1024-1SI	.175 [4.45]	.140 [3.50]	.295 [7.49]	0.128			RFA-4005-302	Peel back Braid to cut Dielectric	
RFN-1024-PL	.175 [4.45]	.140 [3.50]	.295 [7.49]	0.128			RFA-4005-302	Peel back Braid to cut Dielectric	
RFN-1025-1	.177 [4.50]	.177 [4.50]	.177 [4.50]	Solder				2-Step Strip, Dielectric & Braid Same Cut	
RFN-1025-C2	.177 [4.50]	.177 [4.50]	.177 [4.50]	Solder				2-Step Strip, Dielectric & Braid Same Cut	
RFN-1026-1P	.155 [3.94]	.125 [3.18]	.125 [3.18]	0.068			RFA-4009-206	2-Step Strip, Dielectric & Braid Same Cut	
RFN-1026-1X	.167 [4.23]	.125 [3.17]	.125 [3.17]	0.068			RFA-4009-206	2-Step Strip, Dielectric & Braid Same Cut	
RFN-1027	.14 [3.56]	.085 [2.16]	.325 [8.25]	0.1	0.213		RFA-4009-206		
RFN-1027-B	.138 [3.50]	.319 [8.10]	.256 [6.50]	0.1	0.13		RFA-4005-200		
RFN-1027-C1	.14 [3.56]	.085 [2.16]	.325 [8.25]	0.1	0.213		RFA-4009-206		
RFN-1027-C2	.146 [3.70]	.092 [2.34]	.323 [8.20]	0.1	0.213		RFA-4009-206		
RFN-1027-N	.146 [3.70]	.092 [2.34]	.323 [8.20]	0.1	0.213		RFA-4009-206		
RFN-1027-sB	.138 [3.50]	.319 [8.10]	.256 [6.50]	0.1	0.13		RFA-4005-200		
RFN-1028	.20 [5.08]	.055 [1.40]	.325 [8.25]	0.1	0.429		RFA-4009-205		
RFN-1028-2L2	.197 [5.00]	.390 [9.90]	.390 [9.90]	0.184	0.61		RFA-4009-201	2-Step Strip, Dielectric & Braid Same Cut	
RFN-1028-F	.20 [5.08]	.055 [1.40]	.325 [8.25]	0.1	0.429		RFA-4009-205		
RFN-1028-I	.14 [3.56]	.065 [1.65]	.325 [8.25]	0.128	0.429		RFA-4005-200		
RFN-1028-PL	.14 [3.56]	.065 [1.65]	.325 [8.25]	0.128	0.429		RFA-4005-200		
RFN-1028-SI	.14 [3.56]	.065 [1.65]	.325 [8.25]	0.128	0.429		RFA-4005-200		
RFN-1029-SP	.150 [3.81]	.085 [2.16]	.325 [8.25]	0.068	0.255		RFA-4005-203		
RFN-1029-SX	.150 [3.81]	.085 [2.16]	.325 [8.25]	0.068	0.255		RFA-4005-203		
RFN-1041-1									20
RFS-2022	.155 [3.94]	.105 [2.67]	.300 [7.62]	.068	0.213		RFA-4009-206	compression	
RFS-2023	.080 [2.03]	.065 [1.65]	.300 [7.62]	.068	0.213		RFA-4009-206	compression	
RFS-2030								SEE Drawing	
RFS-2068									20
RFT-1200	.14 [3.56]	.07 [1.78]	.21 [5.33]	0.068			RFA-4009-206	Fold braid back before stripping contact and dielectric. Comb braid for clamp installation.	
RFT-1200-C2	.14 [3.56]	.07 [1.78]	.21 [5.33]	0.068			RFA-4009-206	Fold braid back before stripping contact and dielectric. Comb braid for clamp installation.	
RFT-1201-03	.14 [3.56]	.08 [2.03]	.22 [5.59]	Solder					
RFT-1201-1P	.150 [3.80]	.177 [4.50]	.177 [4.50]	0.068			RFA-4009-206	2-Step Strip, Dielectric & Braid Same Cut	
RFT-1201-1X	.150 [3.80]	.177 [4.50]	.177 [4.50]	0.068			RFA-4009-206	2-Step Strip, Dielectric & Braid Same Cut	
RFT-1201-SI	.150 [3.81]	.09 [2.29]	.240 [6.10]	0.128			RFA-4005-300	Fold braid back before stripping contact and dielectric. Comb braid for clamp installation.	
RFT-1202-2	.158 [4.01]	.145 [3.68]	.327 [8.3]	0.068	0.213		RFA-4009-206		
RFT-1202-2B	.16 [4.06]	.145 [3.68]	.325 [8.25]	0.068	0.213		RFA-4009-206		
RFT-1202-2T	.158 [4.01]	.147 [3.73]	.325 [8.26]	0.068	0.213		RFA-4009-206		
RFT-1202-2TC1	.16 [4.06]	.145 [3.68]	.325 [8.25]	0.068	0.213		RFA-4009-206		
RFT-1202-3	.178 [4.52]	.142 [3.6]	.323 [8.20]	0.068	0.13	0.178	RFA-4009-204		
RFT-1202-3B1	.178 [4.52]	.142 [3.6]	.323 [8.20]	0.068	0.13	0.178	RFA-4009-204		
RFT-1202-5	.17 [15.24]	.1 [2.54]	.330 [8.38]	0.068	0.213		RFA-4009-206		
RFT-1202-7	.16 [4.06]	.145 [3.68]	.325 [8.25]	0.068	0.213		RFA-4009-206		



ASSEMBLY & MOUNTING GUIDE — continued

See mounting diagrams in Mounting Configuration section, pages 146-148

Use this as a quick reference. Design changes may slightly alter stripping instructions.
Contact us for drawings and complete assembly instructions.

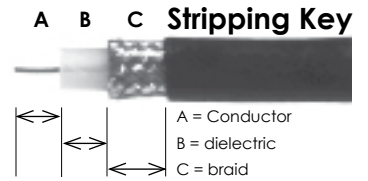

part #	strip A	STRIP B	STRIP C	HEX 1	HEX 2	HEX 3	recommended crimp tool	notes	config-uration
RFT-1202-7T	.16 [4.06]	.145 [3.68]	.325 [8.25]	0.068	0.213		RFA-4009-206		
RFT-1202-C1	.16 [4.06]	.145 [3.68]	.325 [8.25]	0.068	0.213		RFA-4009-206		
RFT-1202-C2	.157 [4.0]	.146 [3.7]	.327 [8.3]	0.068	0.213		RFA-4009-206		
RFT-1202-C2T	.16 [4.06]	.145 [3.68]	.325 [8.25]	0.068	0.213		RFA-4009-206		
RFT-1202-I	.157 [4.0]	.146 [3.7]	.327 [8.3]	0.118	0.429		RFA-4009-205		
RFT-1203-1P	.157 [4.0]	.146 [3.7]	.327 [8.3]	0.068	0.255		RFA-4009-203		
RFT-1203-1X	.157 [4.0]	.146 [3.7]	.327 [8.3]	0.068	0.255		RFA-4009-203		
RFT-1204	.313 [7.94]	.063 [1.60]	.213 [5.42]	0.068			RFA-4009-206	Jacket slit rather than stripped.	
RFT-1206	.563 [14.3]	.252 [6.40]	.252 [6.40]					2-Step Strip, Dielectric & Braid Same Cut	
RFT-1208									35, 42
RFT-1209-1B									35, 44
RFT-1209-B									35, 42
RFT-1209-W-05									35, 42
RFT-1210									16
RFT-1210-03									11
RFT-1210-15									16
RFT-1211-1									4
RFT-1211-1-03									4
RFT-1212	.130 [3.30]	.205 [5.20]	.327 [8.30]	0.068	0.213		RFA-4009-206		35
RFT-1212-B	.157 [4.00]	.205 [5.20]	.331 [8.40]	0.068	0.178		RFA-4009-204		35
RFT-1212-B1	.157 [4.00]	.205 [5.20]	.331 [8.40]	0.068	0.178		RFA-4009-204		35
RFT-1212-C1	.130 [3.30]	.205 [5.20]	.327 [8.30]	0.068	0.213		RFA-4009-206		35
RFT-1212-C2	.130 [3.30]	.205 [5.20]	.327 [8.30]	0.068	0.213		RFA-4009-206		35
RFT-1213-P	.177 [4.50]	.177 [4.50]	.331 [8.40]	0.068	0.255		RFA-4009-203		35
RFT-1213-X	.177 [4.50]	.177 [4.50]	.331 [8.40]	0.068	0.255		RFA-4009-203		35
RFT-1214-I	.157 [4.00]	.138 [3.50]	.295 [7.50]	0.118			RFA-4009-205		
RFT-1216-1	.140 [3.56]	.066 [1.69]	.327 [8.30]	0.068	0.213		RFA-4009-206		
RFT-1216-C1	.140 [3.56]	.066 [1.69]	.327 [8.30]	0.068	0.213		RFA-4009-206		
RFT-1216-C2	.140 [3.56]	.066 [1.69]	.327 [8.30]	0.068	0.213		RFA-4009-206		
RFT-1216-I	.158 [4.01]	.146 [3.71]	.327 [8.31]	0.118	0.429		RFA-4009-205		
RFT-1217-P	.140 [3.56]	.07 [1.72]	.340 [8.64]	0.068	0.255		RFA-4009-203		
RFT-1217-X	.140 [3.56]	.07 [1.72]	.340 [8.64]	0.068	0.255		RFA-4009-203		
RFT-1218	.157 [4.00]	.193 [4.90]	.327 [8.30]	0.068	0.213		RFA-4009-206		
RFT-1218-C1	.157 [4.00]	.195 [4.95]	.325 [8.25]	0.068	0.213		RFA-4009-206		
RFT-1218-C2	.157 [4.00]	.193 [4.90]	.327 [8.30]	0.068	0.213		RFA-4009-206		
RFT-1218-X	.244 [6.20]	.157 [4.00]	.327 [8.30]		0.255		RFA-4009-203		
RFT-1801	.118 [3.00]	.039 [1.00]	.157 [4.00]	0.068			RFA-4009-206		
RFT-1803-1	.158 [4.01]	.145 [3.68]	.327 [8.30]	0.068	0.255		RFA-4009-203		
RFT-1803-R	.157 [4.00]	.327 [8.30]	.327 [8.30]	0.068	0.429		RFA-4009	2-Step Strip, Dielectric & Braid Same Cut	
RFT-1805	.276 [7.01]	.045 [1.14]	.217 [5.5] Slit	Solder				.217 Slit on One Side	
RFT-1813	.157 [4.00]	.205 [5.20]	.327 [8.30]	0.068	0.255		RFA-4009-203		35
RFU-500	.73 [18.54]	.06 [1.52]	.380 [9.65]						
RFU-500-C	.73 [18.54]	.06 [1.52]	.380 [9.65]						
RFU-500-D	.73 [18.54]	.06 [1.52]	.380 [9.65]						
RFU-501	.73 [18.54]	.06 [1.52]	.380 [9.65]						
RFU-501-C	.73 [18.54]	.06 [1.52]	.380 [9.65]						
RFU-501-D	.73 [18.54]	.06 [1.52]	.380 [9.65]						
RFU-503	.74 [18.80]	.160 [4.06]	.220 [5.56]					Fold braid back to trim dielectric.	



ASSEMBLY & MOUNTING GUIDE — continued

See mounting diagrams in Mounting Configuration section, pages 146-148

Use this as a quick reference. Design changes may slightly alter stripping instructions.
Contact us for drawings and complete assembly instructions.

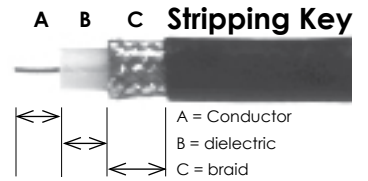

part #	strip A	STRIP B	STRIP C	HEX 1	HEX 2	HEX 3	recommended crimp tool	notes	config-uration
RFU-504	.335 [8.51]	.31 [7.87]	.125 [3.20]						
RFU-505	.71 [18.03]	.295 [7.49]	.325 [8.25]	0.068	0.213		RFA-4009-206		
RFU-505-C1	.613 [15.57]	.296 [7.52]	.323 [8.20]	0.068	0.213		RFA-4009-206		
RFU-505-ST	.731 [18.57]	.277 [7.04]	.323 [8.20]	0.068	0.213		RFA-4009-206		
RFU-505-STC1	.731 [18.57]	.277 [7.04]	.323 [8.20]	0.068	0.213		RFA-4009-206		
RFU-506	.680 [17.27]	.296 [7.52]	.323 [8.20]	0.068	0.255		RFA-4009-203		
RFU-507	.690 [17.53]	.300 [7.62]	.325 [8.25]	0.1	0.429		RFA-4009-205		
RFU-507-PL	.690 [17.53]	.285 [7.24]	.325 [8.25]	0.128	0.429		RFA-4005-300		
RFU-507-S	.630 [16.00]	.295 [7.49]	.323 [8.20]	0.1	0.429		RFA-4009-205		
RFU-507-SI	.680 [17.27]	.268 [6.81]	.323 [8.20]	0.128	0.429		RFA-4005-300		
RFU-507-ST	.690 [17.53]	.285 [7.24]	.325 [8.25]	0.1	0.429		RFA-4009-205		
RFU-507-STF	.669 [17.00]	.248 [6.30]	.441 [11.20]	0.1	0.429		RFA-4009-205		
RFU-507-STF1	.669 [17.00]	.248 [6.30]	.441 [11.20]	0.1	0.429		RFA-4009-205		
RFU-508-P	.690 [17.53]	.305 [7.75]	.325 [8.25]	0.068	0.255		RFA-4009-203		
RFU-508-X	.543 [13.80]	.346 [8.80]	.327 [8.30]	0.068	0.255		RFA-4009-203		
RFU-520	.150 [3.81]	.112 [2.84]	.112 [2.84]	Solder				2-Step Strip, Dielectric & Braid Same Cut	
RFU-520-1E	.125 [3.18]	.085 [2.15]	.210 [5.33]	Solder				Fold braid back to trim dielectric.	
RFU-520-C2	.150 [3.81]	.112 [2.84]	.112 [2.84]	Solder				2-Step Strip, Dielectric & Braid Same Cut	
RFU-520-I	.125 [3.18]	.085 [2.15]	.210 [5.33]	Solder				Fold braid back to trim dielectric.	
RFU-521									20
RFU-521-2T									20
RFU-521-ST									20
RFU-522									19
RFU-523									17
RFU-523-1									35
RFU-523-T									17
RFU-524									17
RFU-527	.14 [3.56]	.065 [1.65]	.325 [8.25]	0.068	0.213		RFA-4009-206		
RFU-527-T	.14 [3.56]	.065 [1.65]	.325 [8.25]	0.068	0.213		RFA-4009-206		
RFU-527-TC1	.14 [3.56]	.065 [1.65]	.325 [8.25]	0.068	0.213		RFA-4009-206		
RFU-600	.65 [16.25]	.10 [2.54]	.150 [3.81]	0.052			RFA-4005-400	Split Jacket two places rather than strip.	
RFU-600-1	.775 [19.69]	.375 [9.53]	.375 [9.53]	0.052	0.213		RFA-4005-400	2-Step Strip, Dielectric & Braid Same Cut	
RFU-600-10C	.157 [4.00]	.193 [4.90]	.327 [8.30]	0.068	0.213		RFA-4009-206		
RFU-600-10C-03	.15 [3.81]	.195 [4.95]	.325 [8.25]	0.068	0.213		RFA-4009-206		
RFU-600-10C1	.708 [17.98]	.331 [8.40]	.331 [8.40]	0.052	0.213		RFA-4005-400	2-Step Strip, Dielectric & Braid Same Cut	
RFU-600-1C1	.16 [4.06]	.025 [.635]	.325 [8.25]	0.068	0.255		RFA-4009-203		
RFU-600-1P	.130 [3.30]	.031 [.79]	.323 [8.20]	0.068	0.255		RFA-4009-203		
RFU-600-1X	.15 [3.81]	.033 [.840]	.331 [8.40]	0.068	0.255		RFA-4009-203		
RFU-600-2	.098 [2.50]	.028 [.711]	.228 [5.80]	0.068	0.213		RFA-4009-206		
RFU-600-3	.15 [3.81]	.051 [1.30]	.327 [8.30]	0.068	0.178		RFA-4009-204		
RFU-600-3B1	.15 [3.81]	.051 [1.30]	.327 [8.30]	0.068	0.178		RFA-4009-204		
RFU-600-5	.17 [4.32]	.035 [.89]	.325 [8.25]	0.068	0.213		RFA-4009-206		
RFU-600-5C1	.17 [4.32]	.035 [.89]	.325 [8.25]	0.068	0.213		RFA-4009-206		
RFU-600-6	.150 [3.80]	.047 [1.19]	.323 [8.20]	0.068	0.213		RFA-4009-206		
RFU-600-6C1	.150 [3.80]	.047 [1.19]	.323 [8.20]	0.068	0.213		RFA-4009-206		
RFU-600-7	.150 [3.80]	.047 [1.19]	.323 [8.20]	0.068	0.213	0.184	RFA-4009-206		
RFU-601-1	.150 [3.80]	.126 [3.20]	.323 [8.20]	0.068	0.213		RFA-4009-206		
RFU-601-1P	.150 [3.80]	.122 [3.10]	.323 [8.20]	0.068	0.255		RFA-4009-203		



ASSEMBLY & MOUNTING GUIDE — continued

See mounting diagrams in Mounting Configuration section, pages 146-148

Use this as a quick reference. Design changes may slightly alter stripping instructions.
Contact us for drawings and complete assembly instructions.

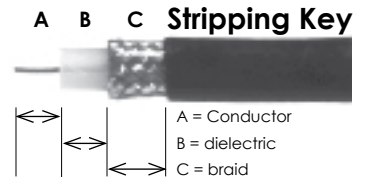

part #	strip A	STRIP B	STRIP C	HEX 1	HEX 2	HEX 3	recommended crimp tool	notes	config-uration
RFU-601-1X	.150 [3.80]	.122 [3.10]	.323 [8.20]	0.068	0.255		RFA-4009-203		
RFU-601-3	.140 [3.57]	.120 [3.05]	.340 [8.64]	0.068	0.178	0.13	RFA-4009-204		
RFU-601-4	.150 [3.80]	.105 [2.67]	.325 [8.25]	0.068	0.255		RFA-4009-203		
RFU-601-5	.150 [3.80]	.043 [1.10]	.295 [7.49]	0.068	0.255		RFA-4009-203		
RFU-601-B1	.140 [3.57]	.120 [3.05]	.340 [8.64]	0.068	0.178	0.13	RFA-4009-204		
RFU-601-C1	.150 [3.80]	.126 [3.20]	.323 [8.20]	0.068	0.213		RFA-4009-206		
RFU-602									4
RFU-602-1									4
RFU-602-1SPL									5
RFU-602-2									4
RFU-602-3									5
RFU-603									12
RFU-603-1									12
RFU-603-2									10
RFU-606-5									5, 26
RFU-617-B	.118 [3.00]	.205 [5.20]	.276 [7.00]	0.068	0.178		RFA-4009-204		4
RFU-617-B1	.118 [3.00]	.205 [5.20]	.276 [7.00]	0.068	0.178		RFA-4009-204		4
RHV-100-D	.118 [3.00]	.276 [7.00]	.236 [6.00]	0.068			RFA-4009-206		
RHV-100-E	.170 [4.32]	.145 [3.68]	.145 [3.68]	0.1			RFA-4009-205		
RHV-106-D	.118 [3.00]	.492 [12.50]	.276 [7.00]	Solder	0.255		RFA-4009-203		
RHV-106-X	.118 [3.00]	.492 [12.50]	.276 [7.00]	Solder	0.255		RFA-4009-203		
RHV-116								.380 Dia. w/ Dbl D-Flats	5
RHV-124-D	.177 [4.50]	.229 [5.82]	.236 [6.00]	0.068			RFA-4009-206		
RMC-6010-B	.045 [1.14]	.085 [2.16]	2.00 [5.08]		0.13		RFA-4009-204		
RMC-6010-B1	.045 [1.14]	.085 [2.16]	2.00 [5.08]		0.13		RFA-4009-204		
RMX-8000-1B	.098 [2.50]	.083 [2.10]	.205 [5.20]	Solder	0.13		RFA-4009-204		
RMX-8000-1B-LCK	.098 [2.50]	.075 [1.90]	.205 [5.20]	Solder	0.13		RFA-4009-204		
RMX-8000-1C	.098 [2.50]	.043 [1.10]	.327 [8.30]	Solder	0.213		RFA-4009-206		
RMX-8000-B	.098 [2.50]	.083 [2.10]	.205 [5.20]	Solder	0.13		RFA-4009-204		
RMX-8000-B1	.099 [2.51]	.082 [2.08]	.205 [5.20]	Solder	0.13		RFA-4009-204		
RMX-8010-1B	.106 [2.69]	.027 [.69]	.205 [5.20]	Solder	0.13		RFA-4009-204		
RMX-8010-1B1	.106 [2.69]	.027 [.69]	.205 [5.20]	Solder	0.13		RFA-4009-204		
RMX-8010-1B-LCK	.079 [2.00]	.127 [3.21]	.204 [5.18]	Solder	0.13		RFA-4009-204		
RMX-8010-1C	.106 [2.69]	.033 [0.85]	.327 [8.30]	SOLDER	.213		rfa-4009-206		
RMX-8010-B	.106 [2.69]	.028 [.70]	.205 [5.20]	Solder	0.13		RFA-4009-204		
RMX-8010-B1	.106 [2.69]	.028 [.70]	.205 [5.20]	Solder	0.13		RFA-4009-204		
RMX-8100-B	.079 [2.00]	.106 [2.69]	.205 [5.20]	Solder	0.13		RFA-4009-204		
RMX-8252-1B	.079 [2.00]	.106 [2.69]	.205 [5.20]	Solder	0.13		RFA-4009-204		2
RMX-8300									23
RMX-8300-1									23
RMX-8350									23
RMX-8350-1									23
RMX-8400-1									23
RMX-8450-1									23
RMX-9000-1A	.078 [1.98]	.083 [2.11]	.185 [4.70]	Solder	0.13		RFA-4009-204		
RMX-9000-1B	.079 [2.00]	.083 [2.10]	.205 [5.20]	Solder	0.13		RFA-4009-204		
RMX-9000-1B1	.079 [2.00]	.083 [2.10]	.205 [5.20]	Solder	0.13		RFA-4009-204		
RMX-9010-1A	.070 [1.78]	.032 [0.81]	.185 [4.70]	Solder	0.13		RFA-4009-204		



ASSEMBLY & MOUNTING GUIDE — continued

See mounting diagrams in Mounting Configuration section, pages 146-148

Use this as a quick reference. Design changes may slightly alter stripping instructions.
Contact us for drawings and complete assembly instructions.

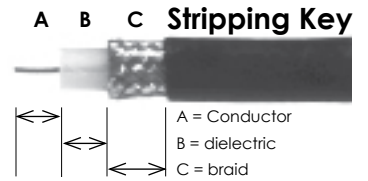

part #	strip A	STRIP B	STRIP C	HEX 1	HEX 2	HEX 3	recommended crimp tool	notes	config-uration
RMX-9010-1B	.071 [1.80]	.031 [0.80]	.205 [5.21]	Solder	0.13		RFA-4009-204		
RMX-9010-1B1	.071 [1.80]	.031 [0.80]	.205 [5.21]	Solder	0.13		RFA-4009-204		
RMX-9050-1B	.079 [2.00]	.102 [2.60]	.205 [5.20]	Solder	0.13		RFA-4009-204		
RMX-9050-1B1	.079 [2.00]	.102 [2.60]	.205 [5.20]	Solder	0.13		RFA-4009-204		
RMX-9060-1B	.055 [1.40]	.079 [2.01]	.213 [5.41]	Solder	0.13		RFA-4009-204		
RMX-9060-1B1	.055 [1.40]	.079 [2.01]	.213 [5.41]	Solder	0.13		RFA-4009-204		
RMX-9350-1									22
RP-1005-C	.157 [4.00]	.146 [3.70]	.327 [8.30]	0.1	0.213		RFA-4009-206		
RP-1006-3I	.157 [4.00]	.146 [3.70]	.327 [8.30]	0.118	0.429		RFA-4009-205		
RP-1028-I	.157 [4.00]	.146 [3.70]	.327 [8.30]	0.118	0.429		RFA-4009-205		
RP-1106-C	.157 [4.00]	.154 [3.90]	.327 [8.30]	0.068	0.213		RFA-4009-206		
RP-1106-C1	.157 [4.00]	.154 [3.90]	.327 [8.30]	0.068	0.213		RFA-4009-206		
RP-1106-C2	.157 [4.00]	.154 [3.90]	.327 [8.30]	0.068	0.213		RFA-4009-206		
RP-1116-NG									4
RP-1117-BT	.138 [3.50]	.248 [6.30]	.394 [10.01]	0.068	0.178		RFA-4009-204		35
RP-1117-C	.157 [4.00]	.205 [5.20]	.327 [8.30]	0.068	0.213		RFA-4009-206		35
RP-1117-C1	.157 [4.00]	.205 [5.20]	.327 [8.30]	0.068	0.213		RFA-4009-206		35
RP-1202-1B	.157 [4.00]	.154 [3.90]	.327 [8.30]	0.068	0.178		RFA-4009-204		
RP-1202-1B1	.157 [4.00]	.154 [3.90]	.327 [8.30]	0.068	0.178		RFA-4009-204		
RP-1202-C	.157 [4.00]	.154 [3.90]	.327 [8.30]	0.068	0.213		RFA-4009-206		
RP-1202-C1	.157 [4.00]	.154 [3.90]	.327 [8.30]	0.068	0.213		RFA-4009-206		
RP-1202-C2	.157 [4.00]	.154 [3.90]	.327 [8.30]	0.068	0.213		RFA-4009-206		
RP-1202-C3	.157 [4.00]	.154 [3.90]	.327 [8.30]	0.068	0.213		RFA-4009-206		
RP-1202-I	.157 [4.00]	.154 [3.90]	.327 [8.30]	0.118	0.429		RFA-4009-205		
RP-1202-L6	.157 [4.00]	.154 [3.90]	.327 [8.30]	0.068	0.324		RFA-4005-308		
RP-1202-X	.157 [4.00]	.154 [3.90]	.327 [8.30]	0.068	0.255		RFA-4009-203		
RP-1210									16
RP-1211-1									4
RP-1212-A	.098 [2.50]	.122 [3.10]	.185 [4.70]	Solder	0.13		RFA-4009-204		35
RP-1212-B	.157 [4.00]	.205 [5.20]	.331 [8.40]	0.068	0.178		RFA-4009-204		35
RP-1212-B1	.157 [4.00]	.205 [5.20]	.331 [8.40]	0.068	0.178		RFA-4009-204		35
RP-1212-C	.157 [4.00]	.205 [5.20]	.327 [8.30]	0.068	0.213		RFA-4009-206		35
RP-1212-C1	.157 [4.00]	.205 [5.20]	.327 [8.30]	0.068	0.213		RFA-4009-206		35
RP-1212-C1-03	.157 [4.00]	.205 [5.20]	.327 [8.30]	0.068	0.213		RFA-4009-206		35
RP-1212-C2	.157 [4.00]	.205 [5.20]	.327 [8.30]	0.068	0.213		RFA-4009-206		35
RP-1212-C3	.157 [4.00]	.205 [5.20]	.327 [8.30]	0.068	0.213		RFA-4009-206		35
RP-1216-C	.157 [4.00]	.146 [3.70]	.327 [8.30]	0.068	0.213		RFA-4009-206		
RP-1216-C1	.157 [4.00]	.146 [3.70]	.327 [8.30]	0.068	0.213		RFA-4009-206		
RP-1216-C2	.157 [4.00]	.146 [3.70]	.327 [8.30]	0.068	0.213		RFA-4009-206		
RP-1216-C3	.157 [4.00]	.146 [3.70]	.327 [8.30]	0.068	0.213		RFA-4009-206		
RP-1216-I	.157 [4.00]	.154 [3.91]	.327 [8.30]	0.118	0.429		RFA-4009-205		
RP-1218	.154 [3.91]	.315 [8.00]	.327 [8.30]	Solder	0.213		RFA-4009-206		
RP-1218-C1	.154 [3.91]	.315 [8.00]	.327 [8.30]	Solder	0.213		RFA-4009-206		
RP-3000-1B	.079 [2.00]	.071 [1.80]	.256 [6.50]	Solder	0.13		RFA-4009-204		
RP-3000-1B1	.079 [2.00]	.071 [1.80]	.256 [6.50]	Solder	0.13		RFA-4009-204		
RP-3000-1C	.079 [2.00]	.067 [1.70]	.327 [8.30]	Solder	0.213		RFA-4009-206		
RP-3000-1C1	.079 [2.00]	.067 [1.70]	.327 [8.30]	Solder	0.213		RFA-4009-206		
RP-3000-1X	.079 [2.00]	.327 [8.30]	.327 [8.30]	Solder	0.255		RFA-4009-203	2-Step Strip, Dielectric & Braid Same Cut	
RP-3000-B	.079 [2.00]	.071 [1.80]	.256 [6.50]	Solder	0.13		RFA-4009-204		



ASSEMBLY & MOUNTING GUIDE — continued

See mounting diagrams in Mounting Configuration section, pages 146-148

Use this as a quick reference. Design changes may slightly alter stripping instructions.
Contact us for drawings and complete assembly instructions.

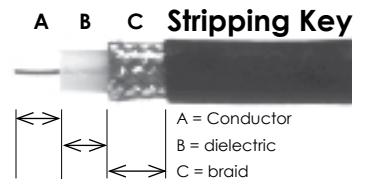

part #	strip A	STRIP B	STRIP C	HEX 1	HEX 2	HEX 3	recommended crimp tool	notes	config-uration
RP-3000-B1	.079 [2.00]	.071 [1.80]	.256 [6.50]	Solder	0.13		RFA-4009-204		
RP-3000-C	.078 [2.0]	.067 [1.7]	.326 [8.3]	Solder	0.213		RFA-4009-206		
RP-3000-C1	.078 [2.0]	.067 [1.7]	.326 [8.3]	Solder	0.213		RFA-4009-206		
RP-3000-C2	.078 [2.0]	.067 [1.7]	.326 [8.3]	Solder	0.213		RFA-4009-206		
RP-3000-I	.157 [4.00]	.150 [3.80]	.327 [8.30]	0.118	0.429		RFA-4009-205		
RP-3010-1B	.102 [2.60]	.114 [2.90]	.205 [5.20]	Solder	0.13		RFA-4009-204		
RP-3010-1B1	.102 [2.60]	.114 [2.90]	.205 [5.20]	Solder	0.13		RFA-4009-204		
RP-3010-1C	.080 [2.03]	.140 [3.55]	.300 [7.62]	Solder	0.213		RFA-4009-206		
RP-3010-1C1	.059 [1.50]	.185 [4.70]	.228 [5.80]	Solder	0.213		RFA-4009-206		
RP-3050-1B	.110 [2.80]	.09 [2.29]	.210 [5.33]	Solder	0.13		RFA-4009-204		
RP-3050-1B1	.110 [2.80]	.09 [2.29]	.210 [5.33]	Solder	0.13		RFA-4009-204		
RP-3050-1C	.110 [2.80]	.107 [2.72]	.295 [7.50]	Solder	0.213		RFA-4009-206		
RP-3050-1C1	.110 [2.80]	.107 [2.72]	.295 [7.50]	Solder	0.213		RFA-4009-206		
RP-3050-1C2	.110 [2.80]	.107 [2.72]	.295 [7.50]	Solder	0.213		RFA-4009-206		
RP-3251-1									3
RP-3252-1B	.098 [2.50]	.091 [2.30]	.205 [5.20]	Solder	0.13		RFA-4009-204		3
RP-3252-1B-03	.098 [2.50]	.099 [2.51]	.235 [5.98]	Solder	0.13		RFA-4009-204		3
RP-3252-1B1	.098 [2.50]	.091 [2.30]	.205 [5.20]	Solder	0.13		RFA-4009-204		3
RP-3252-1C	.098 [2.50]	.090 [2.30]	.326 [8.29]	Solder	0.213		RFA-4009-206		3
RP-3252-1C1	.098 [2.50]	.197 [5.00]	.295 [7.50]	Solder	0.213		RFA-4009-206		3
RP-3252-A-06	.099 [2.51]	.046 [1.17]	.190 [4.83]	Solder	0.1		RFA-4009-206		3
RP-3300									23
RP-3300-1									23
RP-4252-B	.087 [2.20]	.078 [1.99]	.205 [5.20]	Solder	0.13		RFA-4009-204		2
RP-700-179-1	.157 [4.00]	.122 [3.10]	.185 [4.70]	Solder	0.13		RFA-4009-204		
RP-9000-1B	.070 [1.78]	.030 [0.75]	.200 [5.08]	Solder	0.13		RFA-4009-204		
RP-9010-1B	.063 [1.60]	.043 [1.10]	.205 [5.20]	Solder	0.13		RFA-4009-204		
RPT-3000-1C	.079 [2.00]	.067 [1.70]	.327 [8.30]	Solder	0.213		RFA-4009-206		
RPT-3000-C	.079 [2.00]	.067 [1.70]	.327 [8.30]	Solder	0.213		RFA-4009-206		
RQA-5000-C	.079 [2.00]	.075 [1.90]	.327 [8.30]	Solder	0.213		RFA-4009-206		
RQA-5000-C1	.079 [2.00]	.075 [1.90]	.327 [8.30]	Solder	0.213		RFA-4009-206		
RQA-5000-X	.079 [2.00]	.031 [0.79]	.327 [8.30]	0.052	0.255		RFA-4005-400		
RQA-5010-C	.110 [2.79]	.135 [3.44]	.336 [8.54]	Solder	0.213		RFA-4009-206		
RQA-5010-C1	.110 [2.79]	.135 [3.44]	.336 [8.54]	Solder	0.213		RFA-4009-206		
RQA-5010-8X	.118 [3]	.146 [3.7]	.327 [8.3]	N/A	.255				
RQA-5010-X	.248 [6.30]	.327 [8.30]	.327 [8.30]	Solder	0.255		RFA-4009-203	2-Step Strip, Dielectric & Braid Same Cut	
RSA-3000-1B	.098 [2.50]	.067 [1.70]	.256 [6.50]	Solder	0.13		RFA-4009-204		
RSA-3000-1B-03	.098 [2.50]	.067 [1.70]	.256 [6.50]	Solder	0.13		RFA-4009-204		
RSA-3000-1B1	.098 [2.50]	.067 [1.70]	.256 [6.50]	Solder	0.13		RFA-4009-204		
RSA-3000-1C	.079 [2.00]	.067 [1.70]	.327 [8.30]	Solder	0.213		RFA-4009-206		
RSA-3000-1C-03	.079 [2.00]	.067 [1.70]	.327 [8.30]	Solder	0.213		RFA-4009-206		
RSA-3000-1C1	.079 [2.00]	.067 [1.70]	.327 [8.30]	Solder	0.213		RFA-4009-206		
RSA-3000-1C2	.079 [2.00]	.067 [1.70]	.327 [8.30]	Solder	0.213		RFA-4009-206		
RSA-3000-7	.110 [2.80]	.067 [1.70]	.327 [8.30]	Solder	0.13		RFA-4009-204		
RSA-3000-A	.098 [2.50]	.091 [2.30]	.185 [4.70]	Solder	0.13		RFA-4009-204		
RSA-3000-B	.098 [2.50]	.067 [1.70]	.256 [6.50]	Solder	0.13		RFA-4009-204		
RSA-3000-B1	.098 [2.50]	.067 [1.70]	.256 [6.50]	Solder	0.13		RFA-4009-204		
RSA-3000-B-SS	.100 [2.54]	.040 [1.02]	.230 [5.84]	Solder	0.13		RFA-4009-204		



ASSEMBLY & MOUNTING GUIDE — continued

See mounting diagrams in Mounting Configuration section, pages 146-148

Use this as a quick reference. Design changes may slightly alter stripping instructions.
Contact us for drawings and complete assembly instructions.

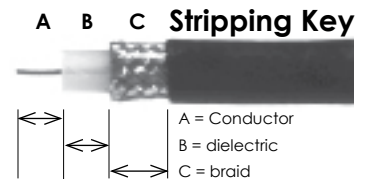

part #	strip A	STRIP B	STRIP C	HEX 1	HEX 2	HEX 3	recommended crimp tool	notes	config-uration
RSA-3000-C	.110 [2.80]	.067 [1.70]	.327 [8.30]	Solder	0.213		RFA-4009-206		
RSA-3000-C1	.138 [3.50]	.067 [1.70]	.327 [8.30]	Solder	0.213		RFA-4009-206		
RSA-3000-C2	.079 [2.01]	.067 [1.70]	.327 [8.30]	Solder	0.213		RFA-4009-206		
RSA-3000-I	.157 [4.00]	.150 [3.80]	.327 [8.30]	0.118	0.429		RFA-4009-205		
RSA-3000-X	.079 [2.00]	.327 [8.31]	.327 [8.31]	0.068	0.255		RFA-4009-203	2-Step Strip, Dielectric & Braid Same Cut	
RSA-3010-1B	.102 [2.60]	.114 [2.90]	.256 [6.50]	Solder	0.13		RFA-4009-204		
RSA-3010-1B-04	.110 [2.79]	.181 [4.60]	.197 [5.00]	Solder	0.13		RFA-4009-204		
RSA-3010-1B1	.102 [2.60]	.114 [2.90]	.256 [6.50]	Solder	0.13		RFA-4009-204		
RSA-3010-1C	.102 [2.60]	.114 [2.90]	.327 [8.31]	Solder	0.213		RFA-4009-206		
RSA-3010-1C1	.102 [2.60]	.114 [2.90]	.327 [8.31]	Solder	0.213		RFA-4009-206		
RSA-3010-7	.102 [2.60]	.114 [2.90]	.327 [8.31]	Solder	0.213		RFA-4009-206		
RSA-3010-B	.102 [2.60]	.114 [2.90]	.256 [6.50]	Solder	0.13		RFA-4009-204		
RSA-3010-B1	.100 [2.54]	.115 [2.92]	.255 [6.48]	Solder	0.13		RFA-4009-204		
RSA-3010-B-SS	.100 [2.54]	.100 [2.54]	.215 [5.46]	Solder	0.13		RFA-4009-204		
RSA-3010-C	.102 [2.60]	.114 [2.90]	.327 [8.31]	Solder	0.213		RFA-4009-206		
RSA-3010-C1	.102 [2.60]	.114 [2.90]	.327 [8.31]	Solder	0.213		RFA-4009-206		
RSA-3010-C2	.161 [4.10]	.126 [3.20]	.327 [8.31]	Solder	0.213		RFA-4009-206		
RSA-3010-X	.157 [4.00]	.126 [3.20]	.327 [8.30]	Solder	0.255		RFA-4009-203		
RSA-3050-1B	.098 [2.49]	.091 [2.31]	.205 [5.21]	Solder	0.13		RFA-4009-204		
RSA-3050-1B1	.098 [2.49]	.091 [2.31]	.205 [5.21]	Solder	0.13		RFA-4009-204		
RSA-3050-1C	.098 [2.49]	.091 [2.31]	.327 [8.31]	Solder	0.213		RFA-4009-206		
RSA-3050-1C1	.098 [2.49]	.091 [2.31]	.327 [8.31]	Solder	0.213		RFA-4009-206		
RSA-3050-1C2	.079 [2.00]	.327 [8.31]	.327 [8.31]	Solder	0.213		RFA-4009-206	2-Step Strip, Dielectric & Braid Same Cut	
RSA-3050-B	.100 [2.54]	.09 [2.29]	.205 [5.20]	Solder	0.13		RFA-4009-204		
RSA-3050-B1	.100 [2.54]	.09 [2.29]	.205 [5.20]	Solder	0.13		RFA-4009-204		
RSA-3050-C	.098 [2.49]	.091 [2.31]	.327 [8.31]	Solder	0.213		RFA-4009-206		
RSA-3050-C1	.098 [2.49]	.091 [2.31]	.327 [8.31]	Solder	0.213		RFA-4009-206		
RSA-3050-C2	.079 [2.00]	.327 [8.31]	.327 [8.31]	Solder	0.213		RFA-4009-206	2-Step Strip, Dielectric & Braid Same Cut	
RSA-3050-X	.079 [2.00]	.327 [8.31]	.327 [8.31]	Solder	0.255		RFA-4009-203	2-Step Strip, Dielectric & Braid Same Cut	
RSA-3100-B	.079 [2.00]	.102 [2.60]	.126 [3.20]	Solder				Fold braid back to trim dielectric, then trim braid.	
RSA-3100-C	.079 [2.00]	.102 [2.60]	.126 [3.20]	Solder				Fold braid back to trim dielectric, then trim braid.	
RSA-3110-B	.102 [2.60]	.126 [3.20]	.126 [3.20]	Solder				2-Step Strip, Dielectric & Braid Same Cut	
RSA-3110-C	.102 [2.60]	.130 [3.30]	.157 [3.99]	Solder				Fold braid back to trim dielectric, then trim braid.	
RSA-3200									3
RSA-3200-1									3
RSA-3221									9
RSA-3231									14
RSA-3232-1									14
RSA-3250									3
RSA-3251									3
RSA-3251-1-10									3
RSA-3252-1B	.098 [2.50]	.091 [2.30]	.205 [5.20]	Solder	0.13		RFA-4009-204		3
RSA-3252-1B1	.098 [2.50]	.091 [2.30]	.205 [5.20]	Solder	0.13		RFA-4009-204		3
RSA-3252-1I	.158 [4.00]	.150 [3.8]	.327 [8.31]	0.118	0.429		RFA-4009-205		3
RSA-3252-A	.098 [2.50]	.220 [5.60]	.185 [4.70]	Solder	0.13		RFA-4009-204		3
RSA-3252-A-4	.100 [2.54]	.040 [1.02]	.270 [6.86]	Solder	0.1		RFA-4009-205		3
RSA-3252-B	.098 [2.50]	.091 [2.30]	.205 [5.20]	0.052	0.13		RFA-4009-204		3
RSA-3252-B-03	.079 [2.00]	.079 [2.00]	.205 [5.20]	Solder	0.13		RFA-4009-204		3
RSA-3252-B1	.100 [2.54]	.090 [2.29]	.205 [5.20]	Solder	0.13		RFA-4009-204		3



ASSEMBLY & MOUNTING GUIDE — continued

See mounting diagrams in Mounting Configuration section, pages 146-148

Use this as a quick reference. Design changes may slightly alter stripping instructions.
Contact us for drawings and complete assembly instructions.

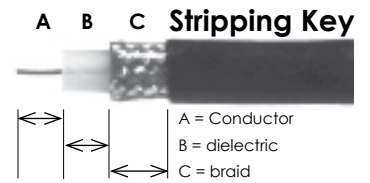

part #	strip A	STRIP B	STRIP C	HEX 1	HEX 2	HEX 3	recommended crimp tool	notes	configuration
RSA-3252-C	.100 [2.54]	.090 [2.29]	.325 [8.26]	Solder	0.213		RFA-4009-206		3
RSA-3252-C1	.098 [2.50]	.091 [2.30]	.327 [8.30]	Solder	0.213		RFA-4009-206		3
RSA-3252-C2	.098 [2.50]	.091 [2.30]	.327 [8.30]	Solder	0.213		RFA-4009-206		3
RSA-3261									9
RSA-3262									9
RSA-3262-1									9
RSA-3268									9
RSA-3269									9
RSA-3270-C	0.098 [2.49]	.091 [2.31]	.327 [8.30]	0.068	0.213		RFA-4009-206		14
RSA-3271									14
RSA-3279									14
RSA-3279-10									14
RSA-3285-03									14
RSA-3290									20
RSA-3290-10									20
RSA-3300									23
RSA-3300-03									3, 23
RSA-3300-1									23
RSA-3300-1-03									3, 23
RSA-3300-NL									3, 25
RSA-3300-NL-03									3, 25
RSA-3350									23
RSA-3350-1									23
RSA-3350-2-1									23
RSA-3500-085	.118 [3.00]			Solder					
RSA-3500-1-085	.118 [3.00]			Solder					
RSA-3500-1-141	.098 [2.50]			Solder					
RSA-3500-141	.098 [2.50]			Solder					
RSA-3500-141-03	.110 [2.80]			Solder					
-03	.110 [2.80]			Solder					
RSA-3510-085	.118 [3.00]			Solder					
RSA-3510-1-085	.118 [3.00]			Solder					
RSA-3510-1-141	.118 [3.00]			Solder					
RSA-3510-141	.118 [3.00]			Solder					
RSA-3550-085	.098 [2.50]			Solder					7
RSA-3550-1-085	.098 [2.50]			Solder					7
RSA-3555-1-047	.098 [2.50]			Solder					
RSA-3555-1SR1	.098 [2.50]			Solder					
RSA-3555-1SR2	.079 [2.00]			Solder					
RSA-3555-SR1	.098 [2.50]			Solder					
RSA-3555-SR2	.079 [2.00]			Solder					
RSA-3560-1-047	.098 [2.50]			Solder					3
RSA-3560-141	.079 [2.00]			Solder					3
RSA-3560-1-SR1	.098 [2.50]			Solder					3
RSA-3565-SR2	.110 [2.79]			Solder					
RSA-3570-085	.079 [2.00]			Solder					31
RSB-200-1-179	.079 [2.01]	.106 [2.69]	.205 [5.20]	Solder	0.13		RFA-4009-204		
RSB-200-1S1	.079 [2.01]	.106 [2.69]	.205 [5.20]	Solder	0.13		RFA-4009-204		



ASSEMBLY & MOUNTING GUIDE — continued

See mounting diagrams in Mounting Configuration section, pages 146-148

Use this as a quick reference. Design changes may slightly alter stripping instructions.
Contact us for drawings and complete assembly instructions.

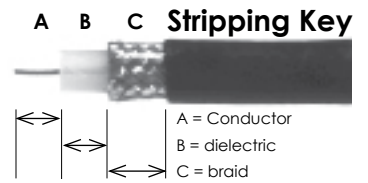

part #	strip A	STRIP B	STRIP C	HEX 1	HEX 2	HEX 3	recommended crimp tool	notes	config-uration
RSB-210-1-179	.102 [2.60]	.075 [1.90]	.205 [5.20]	Solder	0.13		RFA-4009-204		
RSB-210-1-S1	.102 [2.60]	.075 [1.90]	.205 [5.20]	Solder	0.13		RFA-4009-204		
RSB-220-1-179	.079 [2.01]	.106 [2.69]	.205 [5.20]	Solder	0.13		RFA-4009-204		
RSB-221-1-179	.079 [2.01]	.102 [2.60]	.205 [5.20]	Solder	0.13		RFA-4009-204		2
RSB-250-1									50
RSB-255-1									50
RSB-260-1									50
RSB-265-1									23
RSB-300-1-179	.079 [2.01]	.106 [2.69]	.205 [5.20]	Solder	0.13		RFA-4009-204		
RSB-301-179	.079 [2.01]	.091 [2.30]	.205 [5.20]	Solder	0.13		RFA-4009-204		
RSB-310-1-179	.138 [3.50]	.087 [2.20]	.256 [6.50]	Solder	0.13		RFA-4009-204		
RSB-350-1									23
RSB-355-1									23
RSB-4000-1B	.079 [2.01]	.106 [2.70]	.205 [5.20]	Solder	0.13		RFA-4009-204		
RSB-4000-1B1	.079 [2.01]	.106 [2.70]	.205 [5.20]	Solder	0.13		RFA-4009-204		
RSB-4000-B	.102 [2.60]	.075 [1.90]	.256 [6.50]	Solder	0.13		RFA-4009-204		
RSB-4000-B-03	.079 [2.00]	.106 [2.69]	.205 [5.21]	Solder	0.13		RFA-4009-204		
RSB-4000-B1	.102 [2.60]	.075 [1.90]	.256 [6.50]	Solder	0.13		RFA-4009-204		
RSB-4010-1B	.102 [2.60]	.075 [1.90]	.256 [6.50]	Solder	0.13		RFA-4009-204		
RSB-4010-1B1	.102 [2.60]	.075 [1.90]	.256 [6.50]	Solder	0.13		RFA-4009-204		
RSB-4010-B	.059 [1.50]	.075 [1.90]	.256 [6.50]	Solder	0.13		RFA-4009-204		
RSB-4010-B1	.059 [1.50]	.075 [1.90]	.256 [6.50]	Solder	0.13		RFA-4009-204		
RSB-4050-1B	.098 [2.50]	.106 [2.70]	.205 [5.20]	Solder	0.13		RFA-4009-204		
RSB-4050-1B1	.098 [2.50]	.106 [2.70]	.205 [5.20]	Solder	0.13		RFA-4009-204		
RSB-4050-B	.079 [2.01]	.106 [2.70]	.205 [5.20]	Solder	0.13		RFA-4009-204		
RSB-4050-B1	.079 [2.01]	.106 [2.70]	.205 [5.20]	Solder	0.13		RFA-4009-204		
RSB-4055-1B	.102 [2.60]	.075 [1.90]	.256 [6.50]	Solder	0.13		RFA-4009-204		
RSB-4055-1B1	.102 [2.60]	.075 [1.90]	.256 [6.50]	Solder	0.13		RFA-4009-204		
RSB-4100-B	.110 [2.79]	.060 [1.52]	.197 [5.00]	Solder				Slit cable jacket rather than strip.	
RSB-4251									2
RSB-4251-1									2
RSB-4252-1B	.079 [2.01]	.106 [2.70]	.205 [5.20]	Solder	0.13		RFA-4009-204		2
RSB-4252-1B1	.079 [2.01]	.106 [2.70]	.205 [5.20]	Solder	0.13		RFA-4009-204		2
RSB-4252-B	.079 [2.01]	.106 [2.70]	.205 [5.20]	Solder	0.13		RFA-4009-204		2
RSB-4252-B1	.079 [2.01]	.106 [2.70]	.205 [5.20]	Solder	0.13		RFA-4009-204		2
RSB-4300									23
RSB-4300-1									23
RSB-4301-1									23
RSB-4350									23
RSB-4350-1									
RSB-4350-1-75									23
RSB-4400-1									23
RSB-710-1B	.079 [2.00]	.035 [0.90]	.213 [5.40]	0.13			RFA-4009-204		
RSB-750-1B	.079 [2.00]	.032 [0.81]	.205 [5.21]	SOLDER	0.13		RFA-4009-204		
RSB-750-1B1	.079 [2.00]	.032 [0.81]	.205 [5.21]	SOLDER	0.13		RFA-4009-204		
RT-1005-C	.157 [4.00]	.146 [3.71]	.327 [8.30]	0.1	0.213		RFA-4009-206		
RT-1005-C1	.157 [4.00]	.146 [3.71]	.327 [8.30]	0.1	0.213		RFA-4009-206		
RT-1009-C1-03	.157 [4.00]	.327 [8.30]	.327 [8.30]	SOLDER	0.213		RFA-4009-206		



ASSEMBLY & MOUNTING GUIDE — continued

See mounting diagrams in Mounting Configuration section, pages 146-148

Use this as a quick reference. Design changes may slightly alter stripping instructions.

Contact us for drawings and complete assembly instructions.

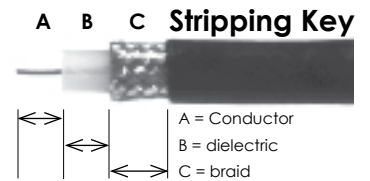

part #	strip A	STRIP B	STRIP C	HEX 1	HEX 2	HEX 3	recommended crimp tool	notes	config-uration
RT-1200-C	.157 [4.0]	.134 [3.40]	.291 [7.39]	0.068			RFA-4009-206	Fold braid back to trim dielectric.	
RT-1200-I	.150 [3.81]	.090 [2.29]	.240 [6.10]	0.128			RFA-4005-300		
RT-1202-C	.157 [4.00]	.146 [3.70]	.327 [8.30]	0.068	0.213		RFA-4009-206		
RT-1202-C1	.157 [4.00]	.146 [3.70]	.327 [8.30]	0.068	0.213		RFA-4009-206		
RT-1202-I	.157 [4.00]	.146 [3.70]	.327 [8.30]	0.128	0.429		RFA-4005-200		
RT-1203-1X	.157 [4.00]	.146 [3.70]	.327 [8.30]	0.068	0.255		RFA-4009-203		
RT-1208							2 Holes .400" O/C	.510 Dia. w/ 3 D-Flats	37, 42
RT-1209-B									35, 42
RT-1211-1								.380 Dia. D-Flat	4
RT-3000-1C	.138 [3.50]	.067 [1.70]	.327 [8.30]	Solder	0.213		RFA-4009-206		
RT-3000-1C1	.135 [3.43]	.07 [1.78]	.325 [8.26]	Solder	0.213		RFA-4009-206		
RT-3252-1B-04	.120 [3.05]	.115 [2.92]	.205 [5.21]	Solder	0.13		RFA-4009-204		
RT-3252-1B1-04	.120 [3.05]	.115 [2.92]	.205 [5.21]	Solder	0.13		RFA-4009-204		
RT-3252-1C	.098 [2.50]	.091 [2.31]	.327 [8.31]	Solder	0.213		RFA-4009-206		
RT-3252-1C1	.098 [2.50]	.091 [2.31]	.327 [8.31]	Solder	0.213		RFA-4009-206		